

LAMP

ACIL AYDINLATMA KİTİ

PC 1/14-35/49/54 T5 PRO-M Ip

TRIDONIC BALLAST

L

N

E

12

11

10

9

8

7

6

5

4

3

2

1

Balasta ve kite aynı anda enerji verildiğinde, lamba şebekeden yanar.  
Acil aydınlatma kiti enerjisi kesildiğinde, lamba acil aydınlatma ışığı verir.

LAMP

ACIL AYDINLATMA KİTİ

PC 1/14-35/49/80 T5 PRO-M Ip

TRIDONIC BALLAST

L

N

E

12

11

10

9

8

7

6

5

4

3

2

1

Balasta ve kite aynı anda enerji verildiğinde, lamba şebekeden yanar.  
Acil aydınlatma kiti enerjisi kesildiğinde, lamba acil aydınlatma ışığı verir.

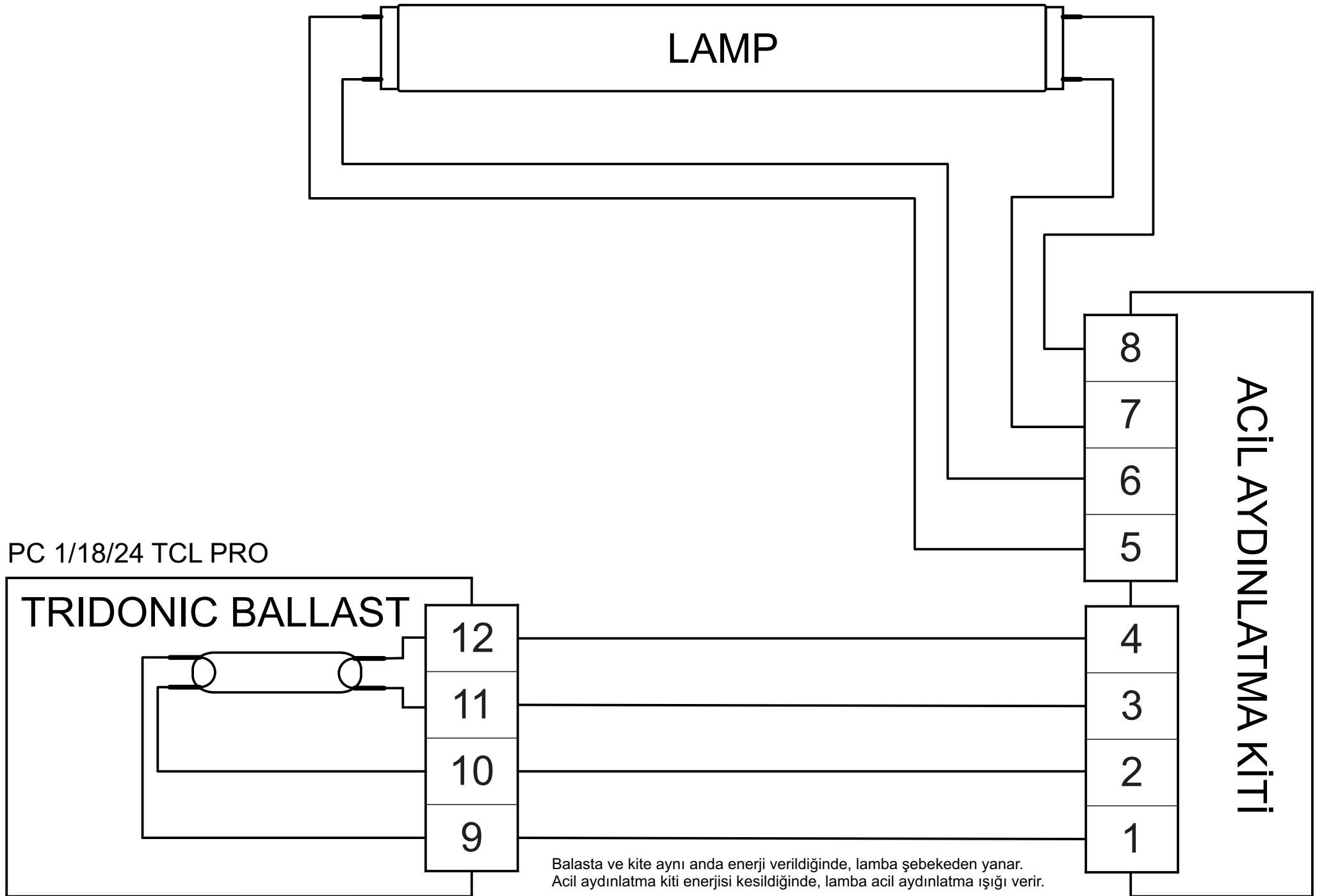

PC 1/18/24 TCL PRO

TRIDONIC BALLAST

LAMP

ACİL AYDINLATMA KİTİ

Balasta ve kite aynı anda enerji verildiğinde, lamba şebekeden yanar.  
Acil aydınlatma kiti enerjisi kesildiğinde, lamba acil aydınlatma ışığı verir.

PC 1/28 DD PRO sc

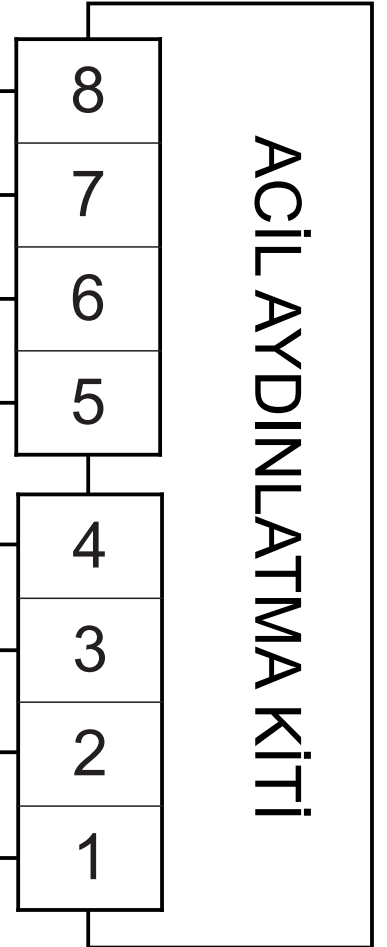
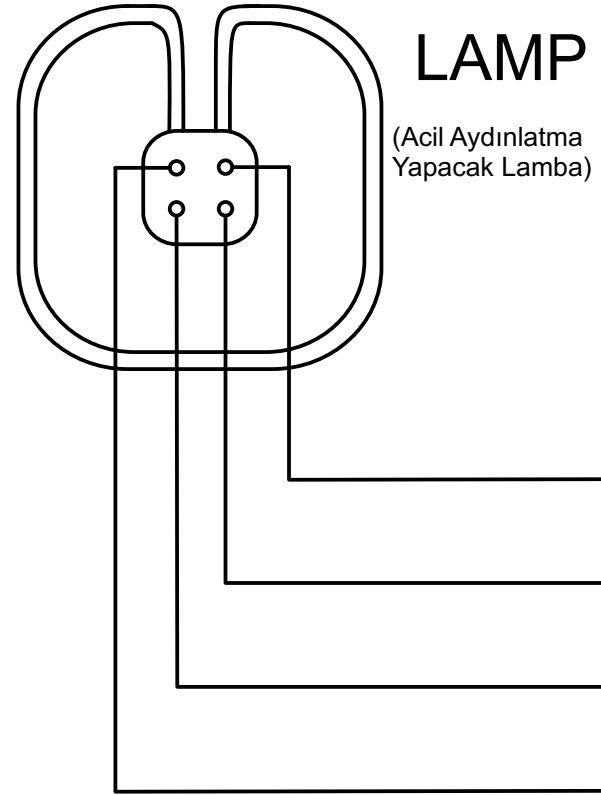
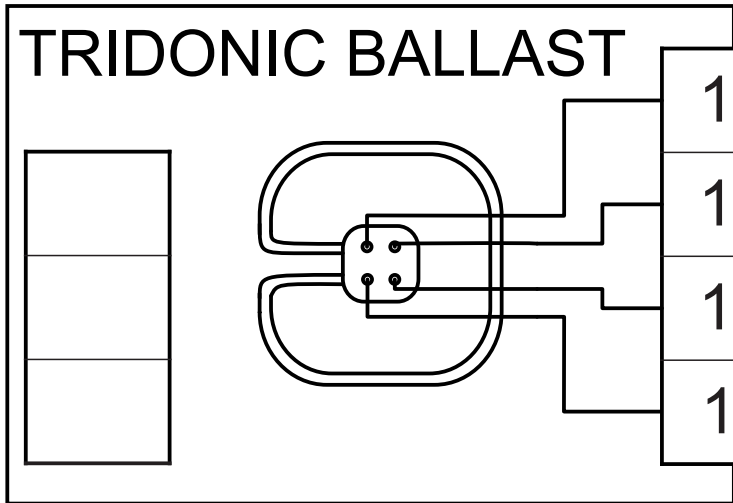

Balasta ve kite aynı anda enerji verildiğinde, lampa şebekeden yanar.  
Acil aydınlatma kiti enerjisi kesildiğinde, lampa acil aydınlatma ışığı verir.

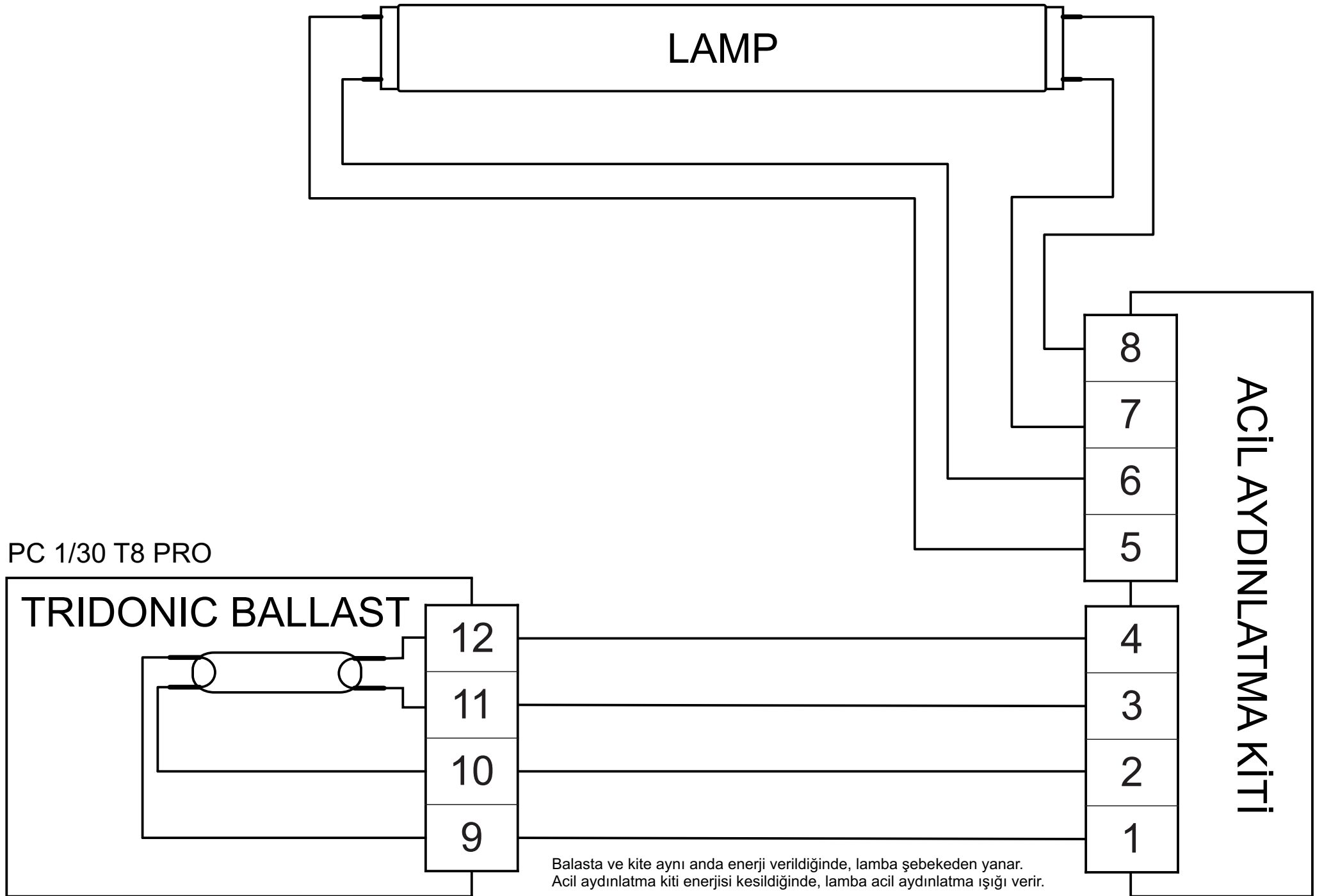

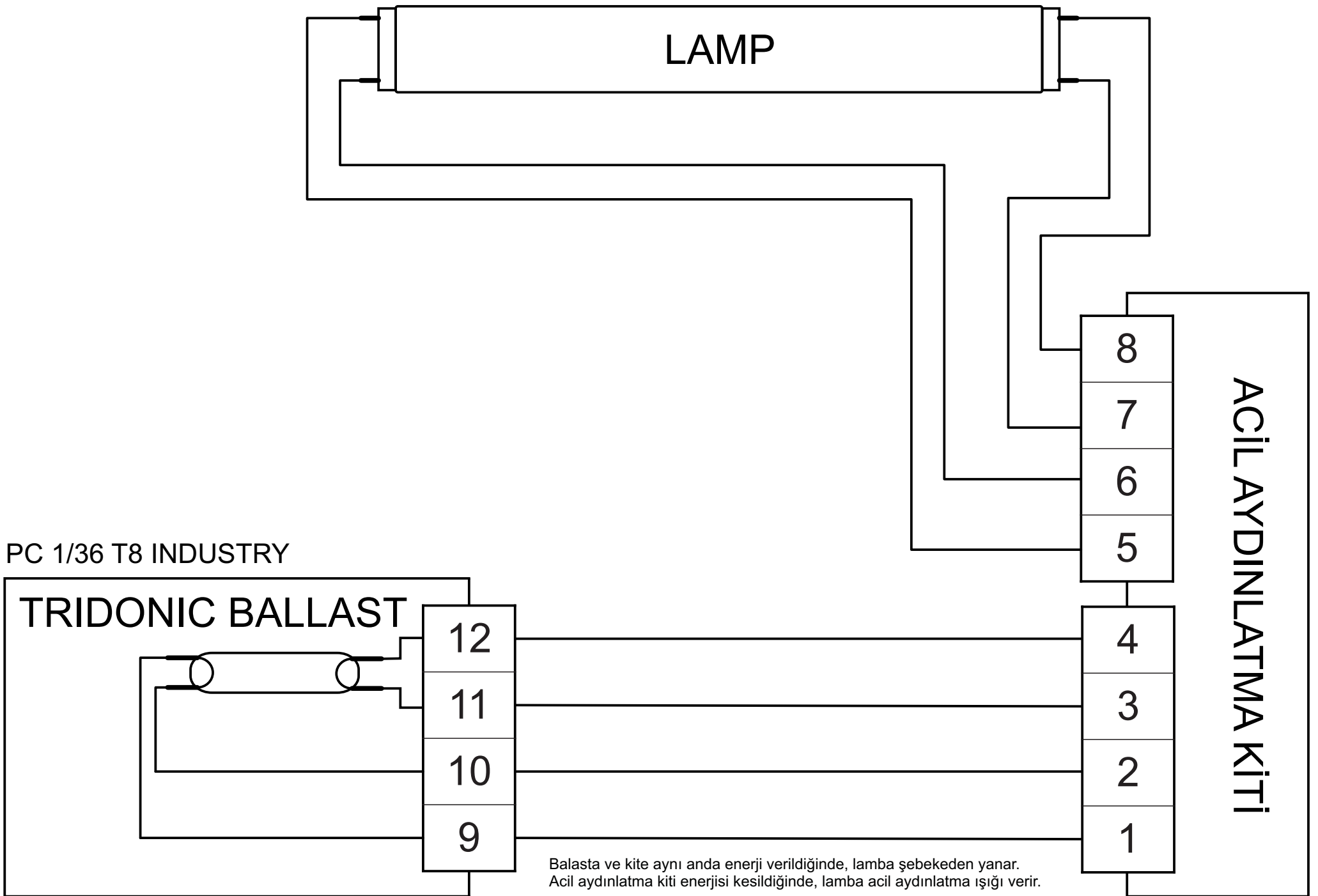

PC 1/36 T8 INDUSTRY

LAMP

TRIDONIC BALLAST

ACİL AYDINLATMA KİTİ

Balasta ve kite aynı anda enerji verildiğinde, lamba şebekeden yanar.  
Acil aydınlatma kiti enerjisi kesildiğinde, lamba acil aydınlatma ışığı verir.

LAMP

ACIL AYDINLATMA KİTİ

PC 1/36 T8 PRO sc

TRIDONIC BALLAST

L

N

E

14

13

12

11

8

7

6

5

4

3

2

1

Balasta ve kite aynı anda enerji verildiğinde, lamba şebekeden yanar.  
Acil aydınlatma kiti enerjisi kesildiğinde, lamba acil aydınlatma ışığı verir.



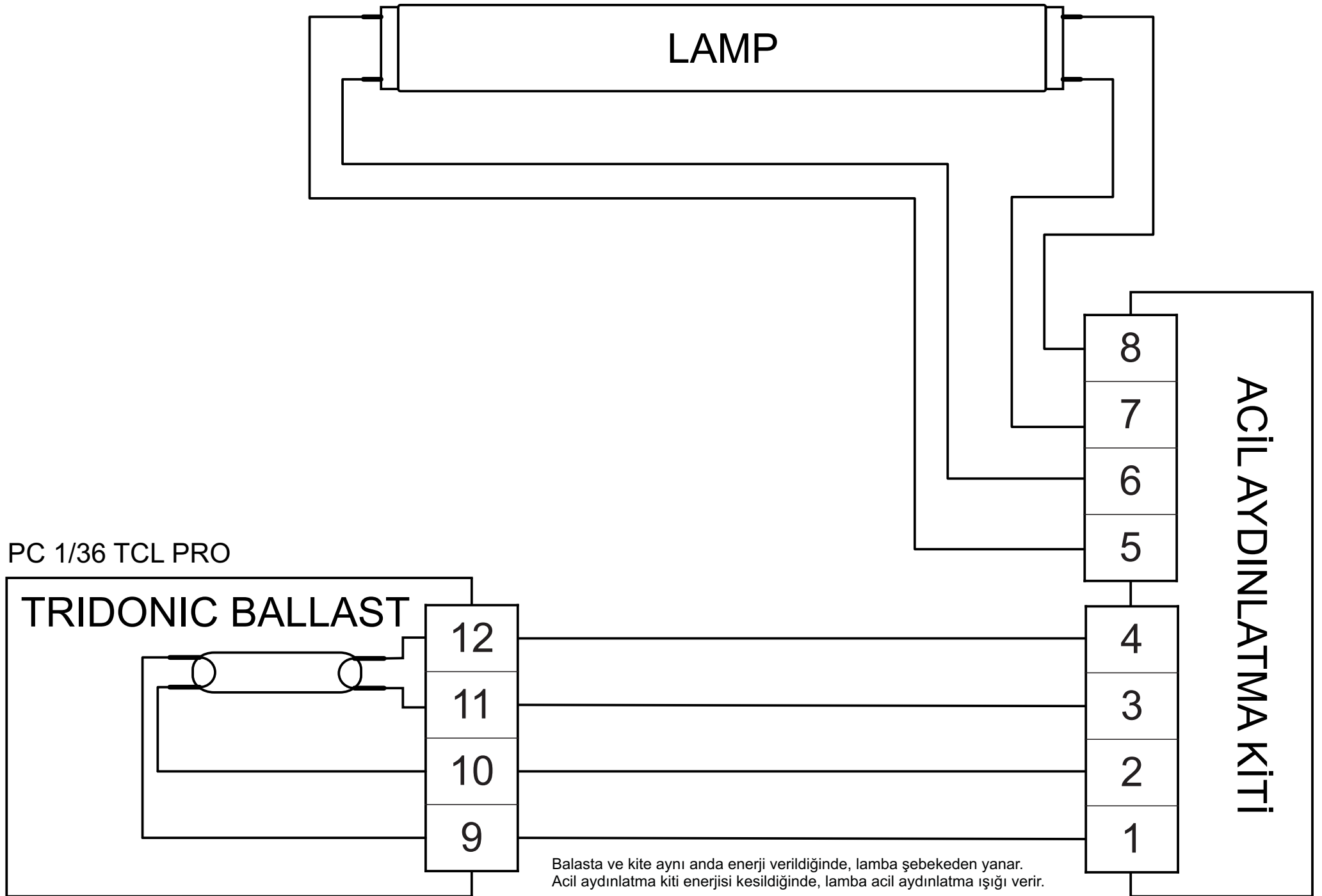

PC 1/36 TCL PRO

TRIDONIC BALLAST

12

11

10

9

8

7

6

5

4

3

2

1

ACİL AYDINLATMA KİTİ

LAMP

Balasta ve kite aynı anda enerji verildiğinde, lamba şebekeden yanar.  
Acil aydınlatma kiti enerjisi kesildiğinde, lamba acil aydınlatma ışığı verir.

PC 1/38 DD PRO sc

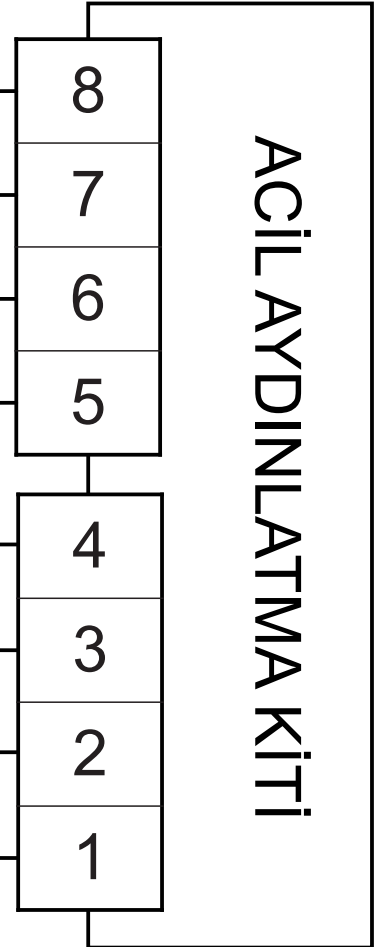
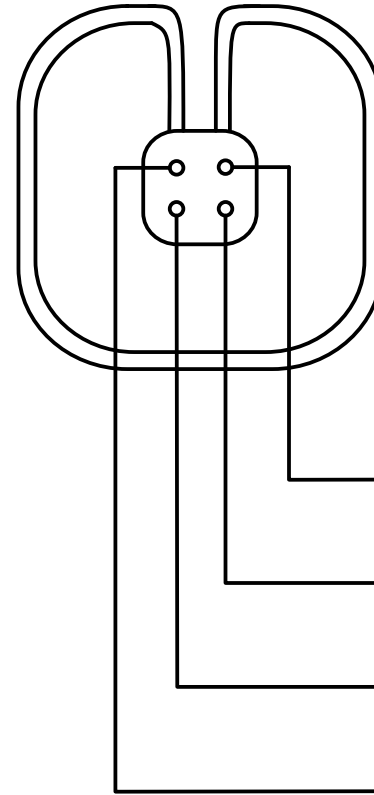
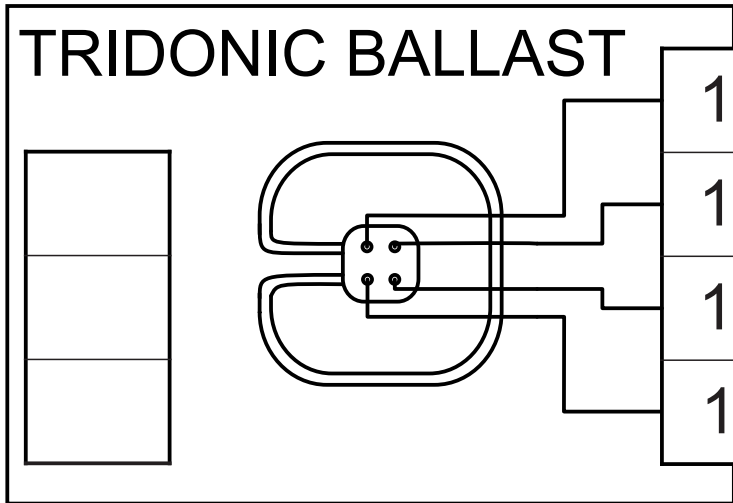

Balasta ve kite aynı anda enerji verildiğinde, lampa şebekeden yanar.  
Acil aydınlatma kiti enerjisi kesildiğinde, lampa acil aydınlatma ışığı verir.

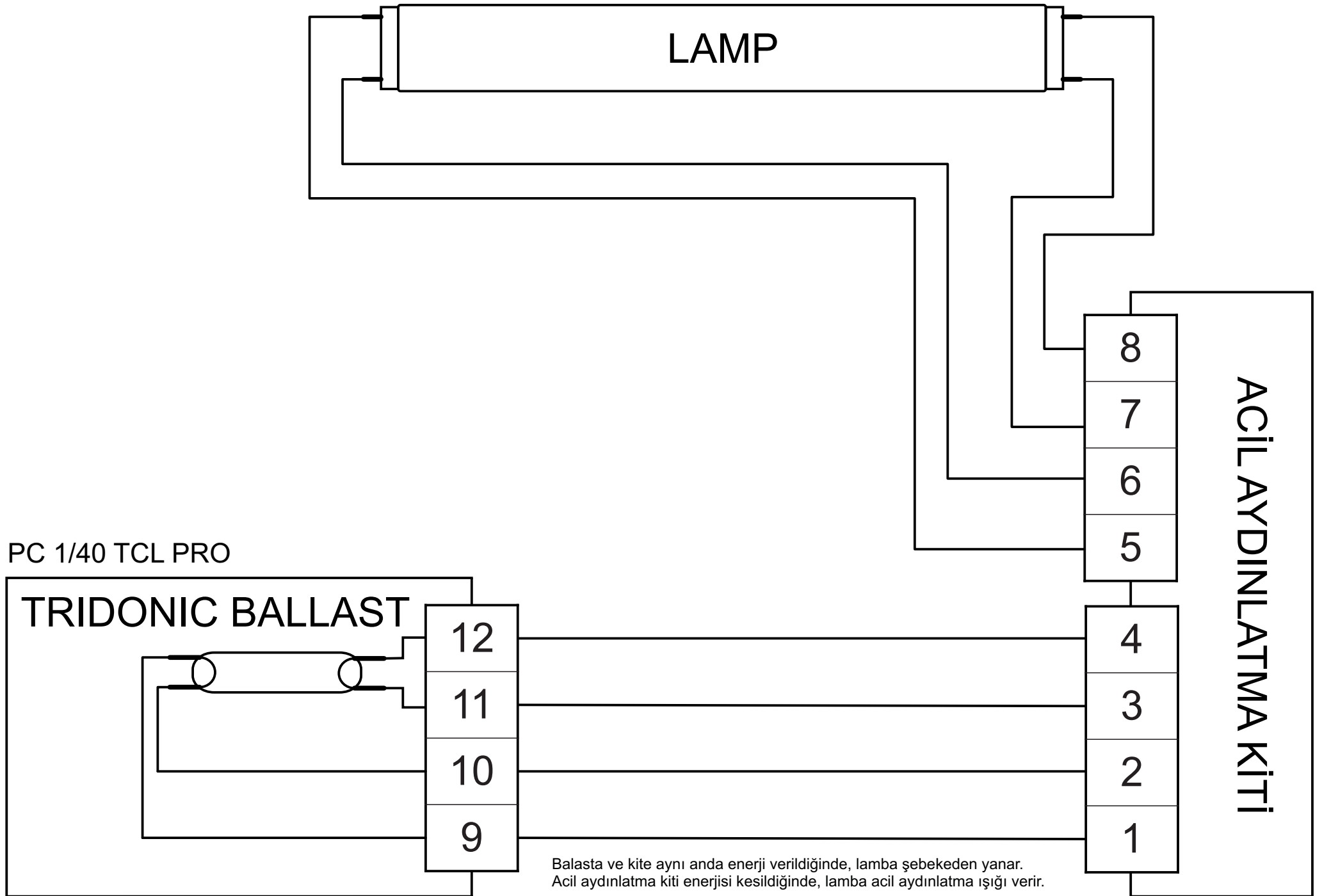

PC 1/40 TCL PRO

TRIDONIC BALLAST

12

11

10

9

8

7

6

5

4

3

2

1

ACİL AYDINLATMA KİTİ

LAMP

Balasta ve kite aynı anda enerji verildiğinde, lamba şebekeden yanar.  
Acil aydınlatma kiti enerjisi kesildiğinde, lamba acil aydınlatma ışığı verir.

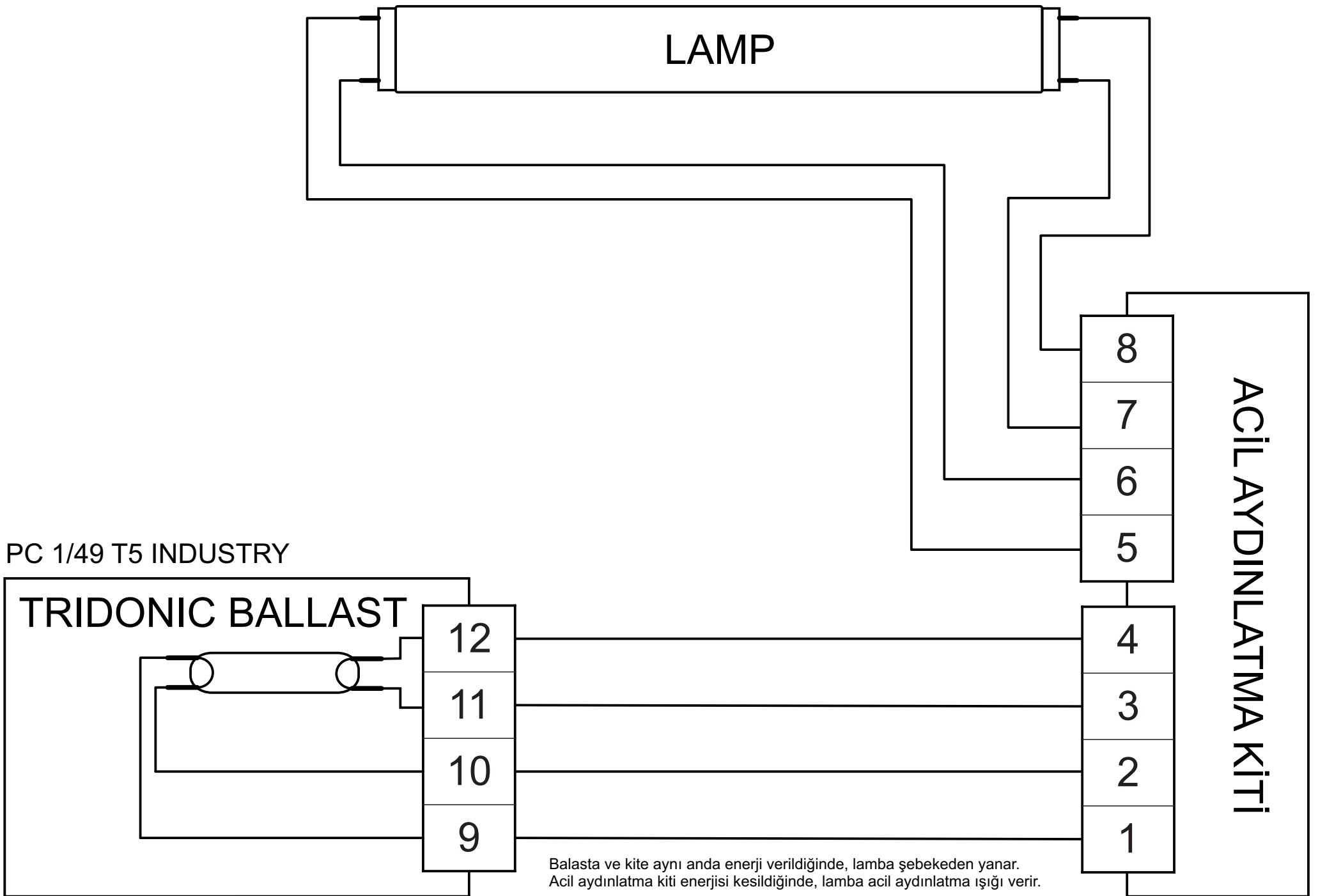

PC 1/49 T5 INDUSTRY

TRIDONIC BALLAST

12

11

10

9

8

7

6

5

4

3

2

1

ACİL AYDINLATMA KİTİ

LAMP

Balasta ve kite aynı anda enerji verildiğinde, lamba şebekeden yanar.  
Acil aydınlatma kiti enerjisi kesildiğinde, lamba acil aydınlatma ışığı verir.

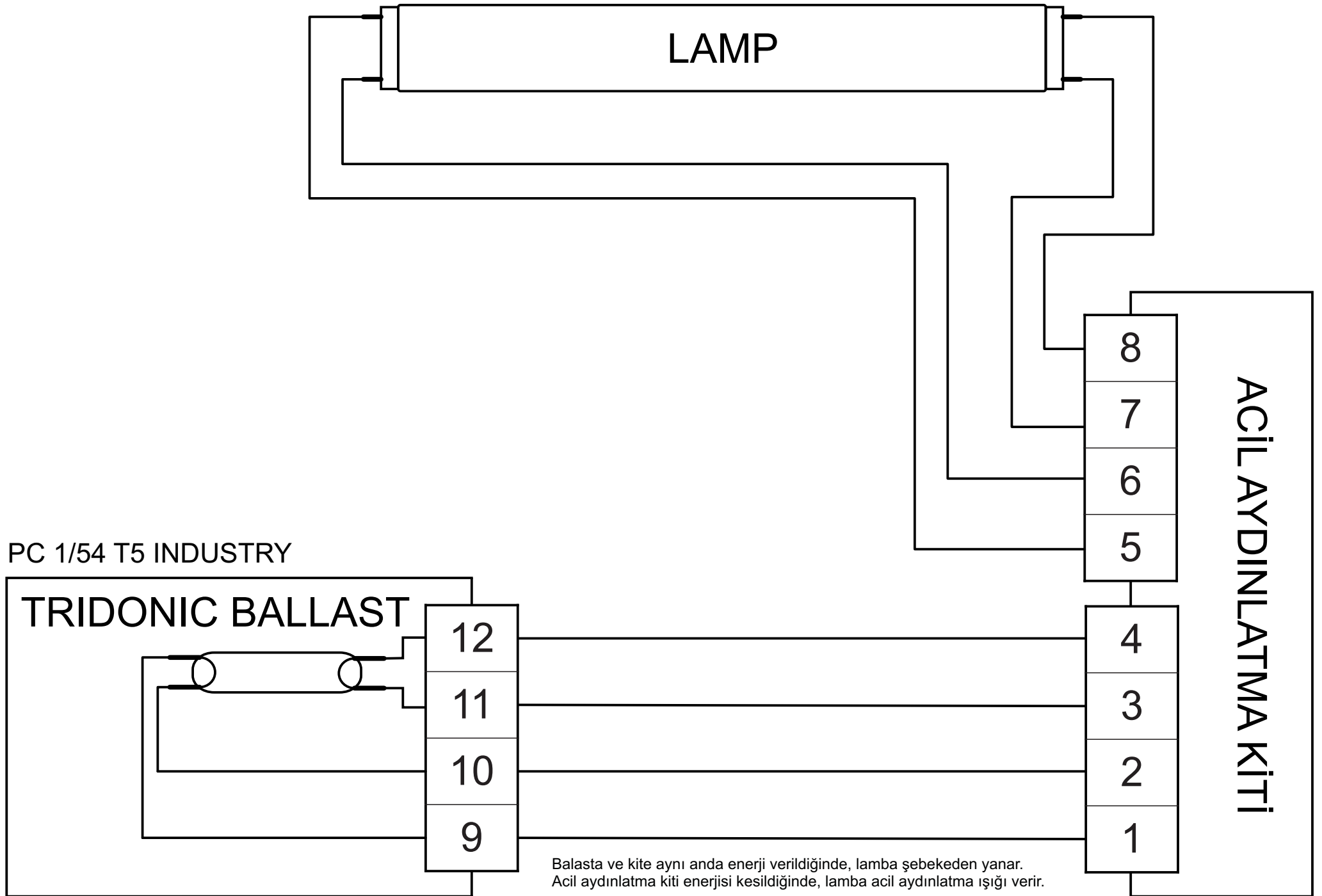

PC 1/54 T5 INDUSTRY

TRIDONIC BALLAST

12

11

10

9

8

7

6

5

4

3

2

1

ACİL AYDINLATMA KİTİ

LAMP

Balasta ve kite aynı anda enerji verildiğinde, lamba şebekeden yanar.  
Acil aydınlatma kiti enerjisi kesildiğinde, lamba acil aydınlatma ışığı verir.

PC 1/55 DD PRO sc

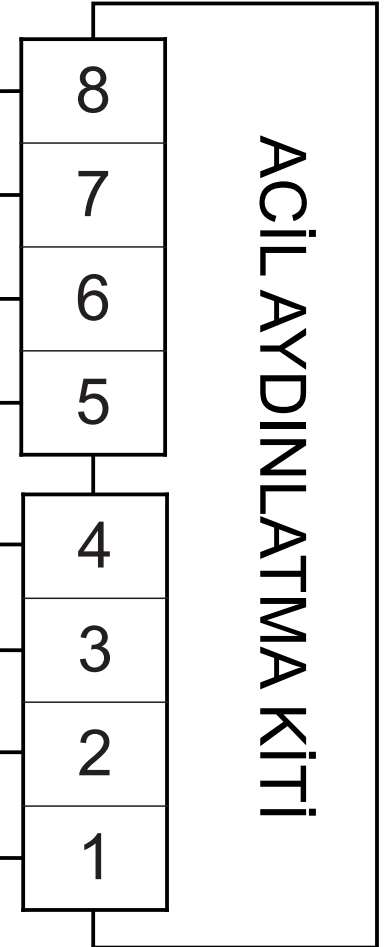
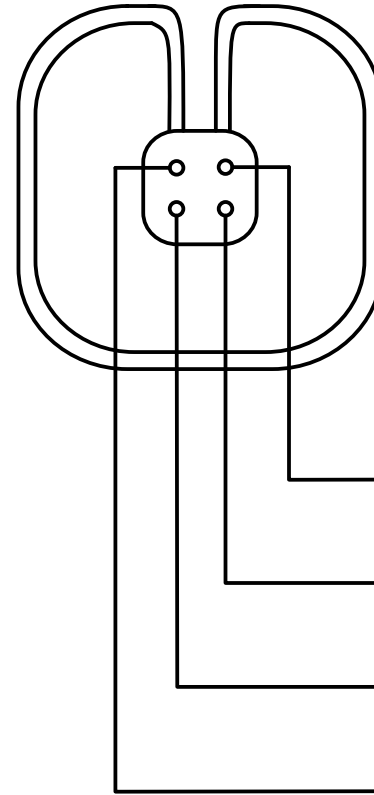
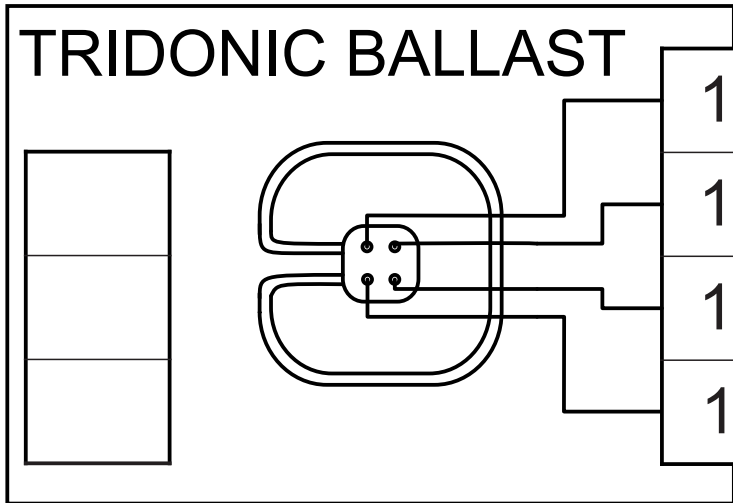

Balasta ve kite aynı anda enerji verildiğinde, lampa şebekeden yanar.  
Acil aydınlatma kiti enerjisi kesildiğinde, lampa acil aydınlatma ışığı verir.

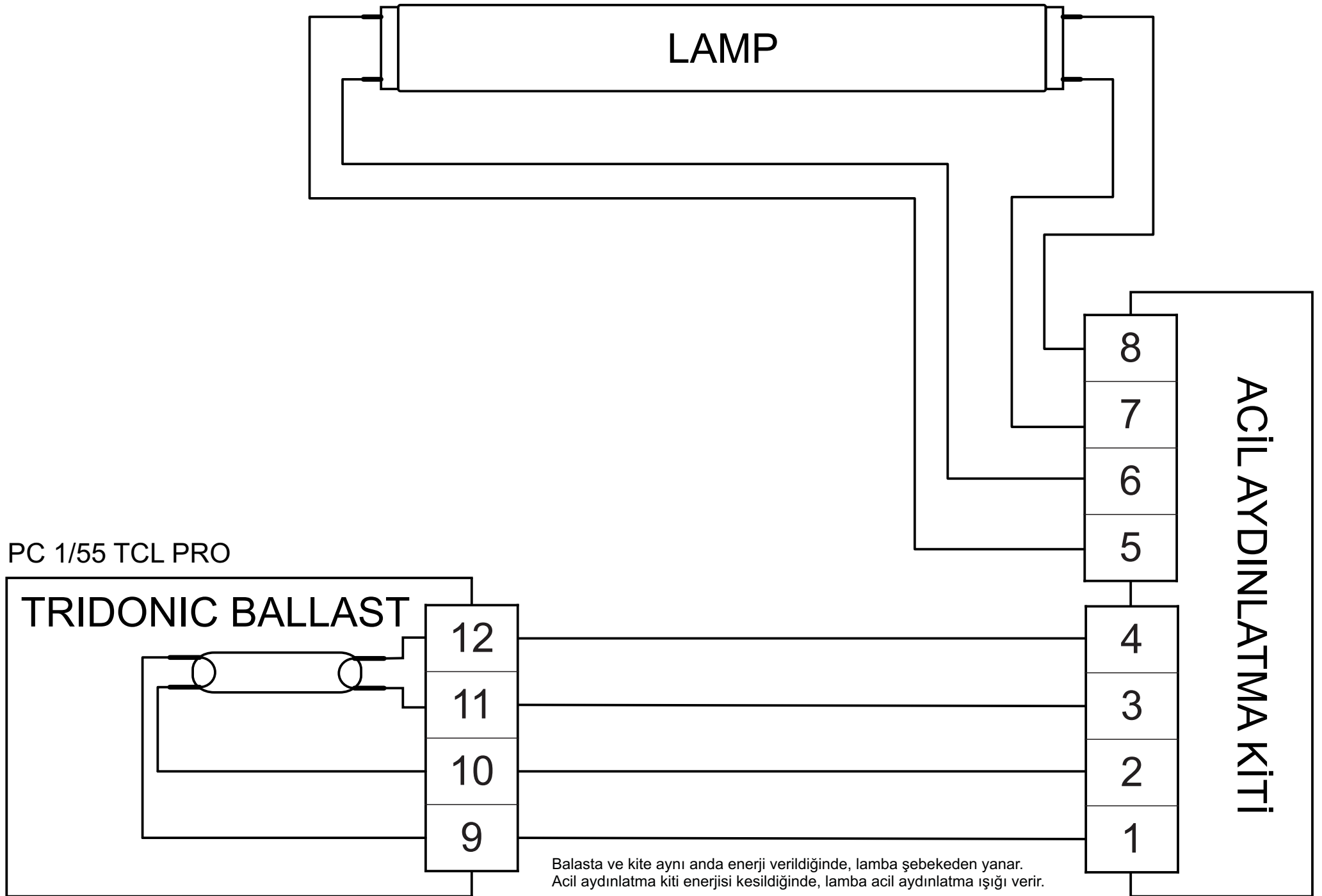

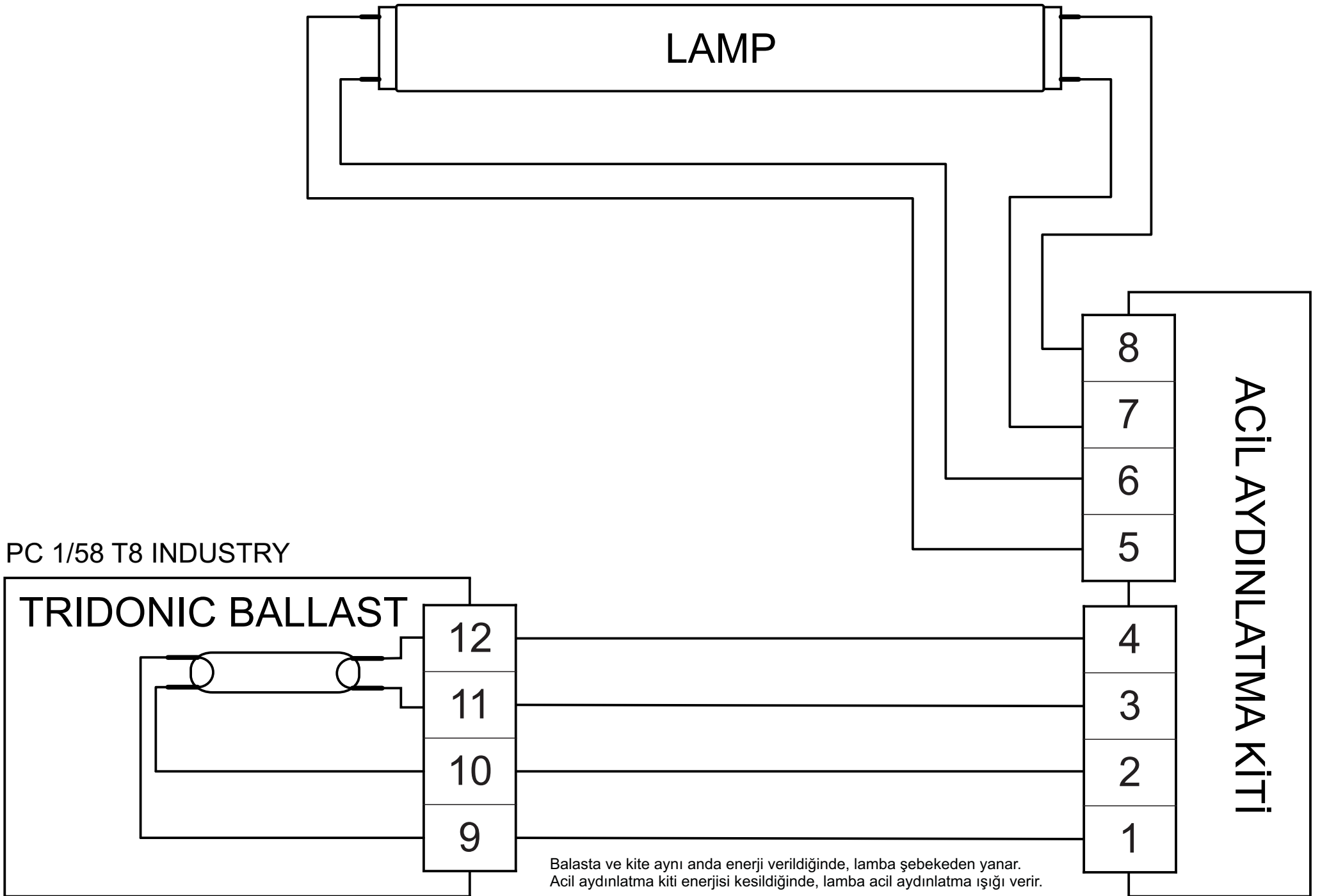

PC 1/58 T8 INDUSTRY

TRIDONIC BALLAST

12

11

10

9

8

7

6

5

4

3

2

1

ACİL AYDINLATMA KİTİ

LAMP

Balasta ve kite aynı anda enerji verildiğinde, lamba şebekeden yanar.  
Acil aydınlatma kiti enerjisi kesildiğinde, lamba acil aydınlatma ışığı verir.



LAMP

ACIL AYDINLATMA KİTİ

PC 1/58 T8 PRO sc

TRIDONIC BALLAST

L

N

E

14

13

12

11

8

7

6

5

4

3

2

1

Balasta ve kite aynı anda enerji verildiğinde, lamba şebekeden yanar.  
Acil aydınlatma kiti enerjisi kesildiğinde, lamba acil aydınlatma ışığı verir.

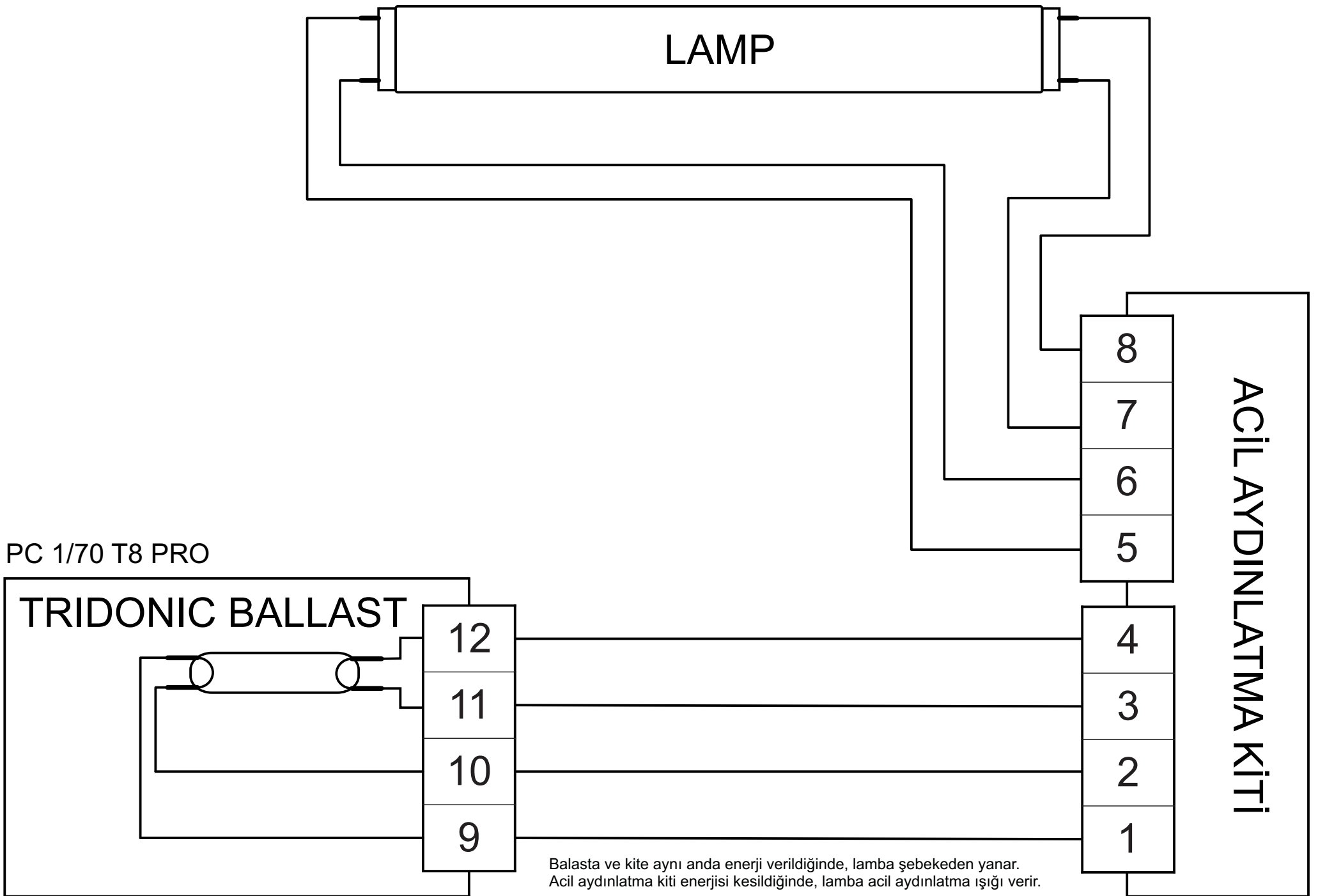

PC 1/70 T8 PRO

TRIDONIC BALLAST

LAMP

ACİL AYDINLATMA KİTİ

Balasta ve kite aynı anda enerji verildiğinde, lamba şebekeden yanar.  
Acil aydınlatma kiti enerjisi kesildiğinde, lamba acil aydınlatma ışığı verir.

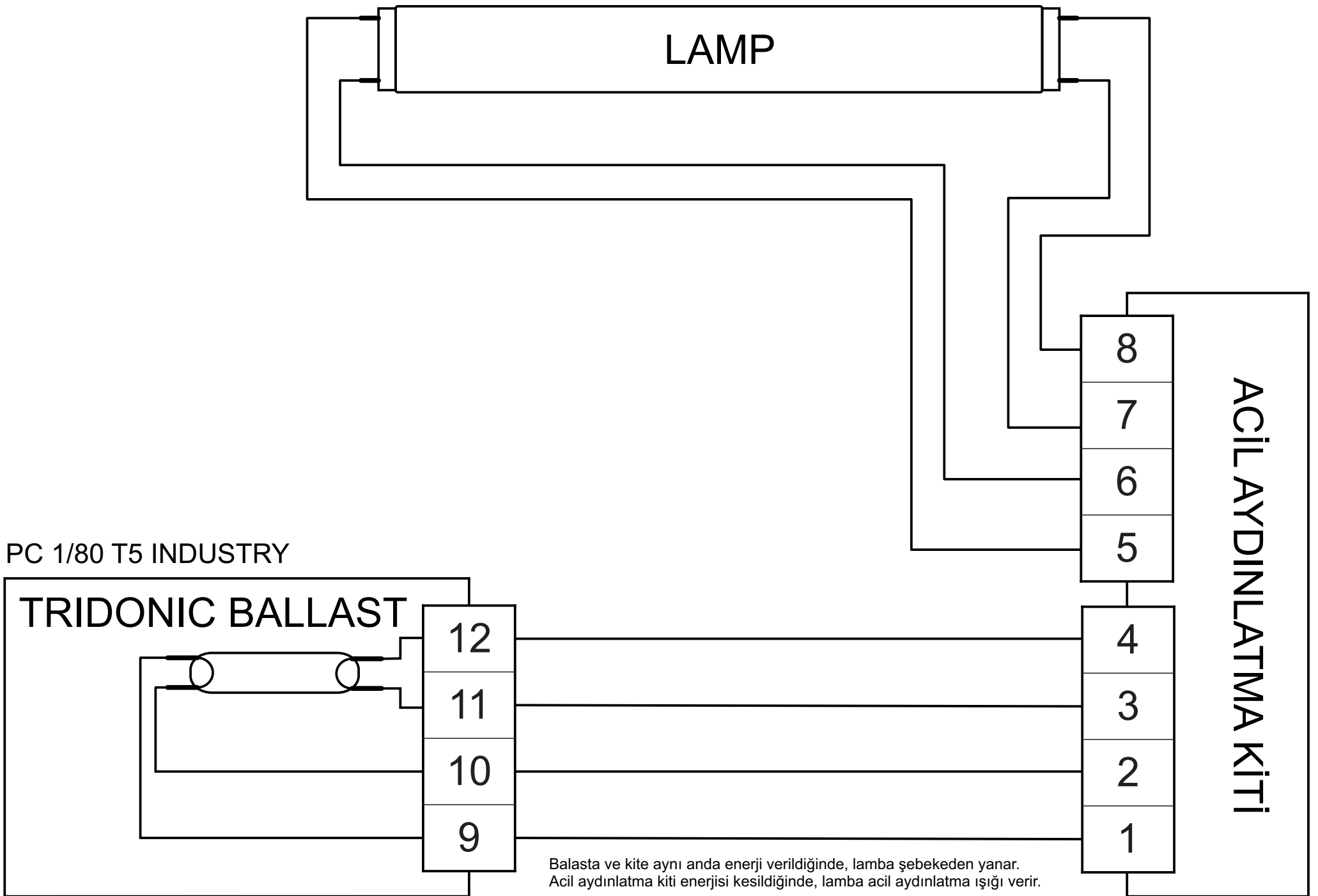

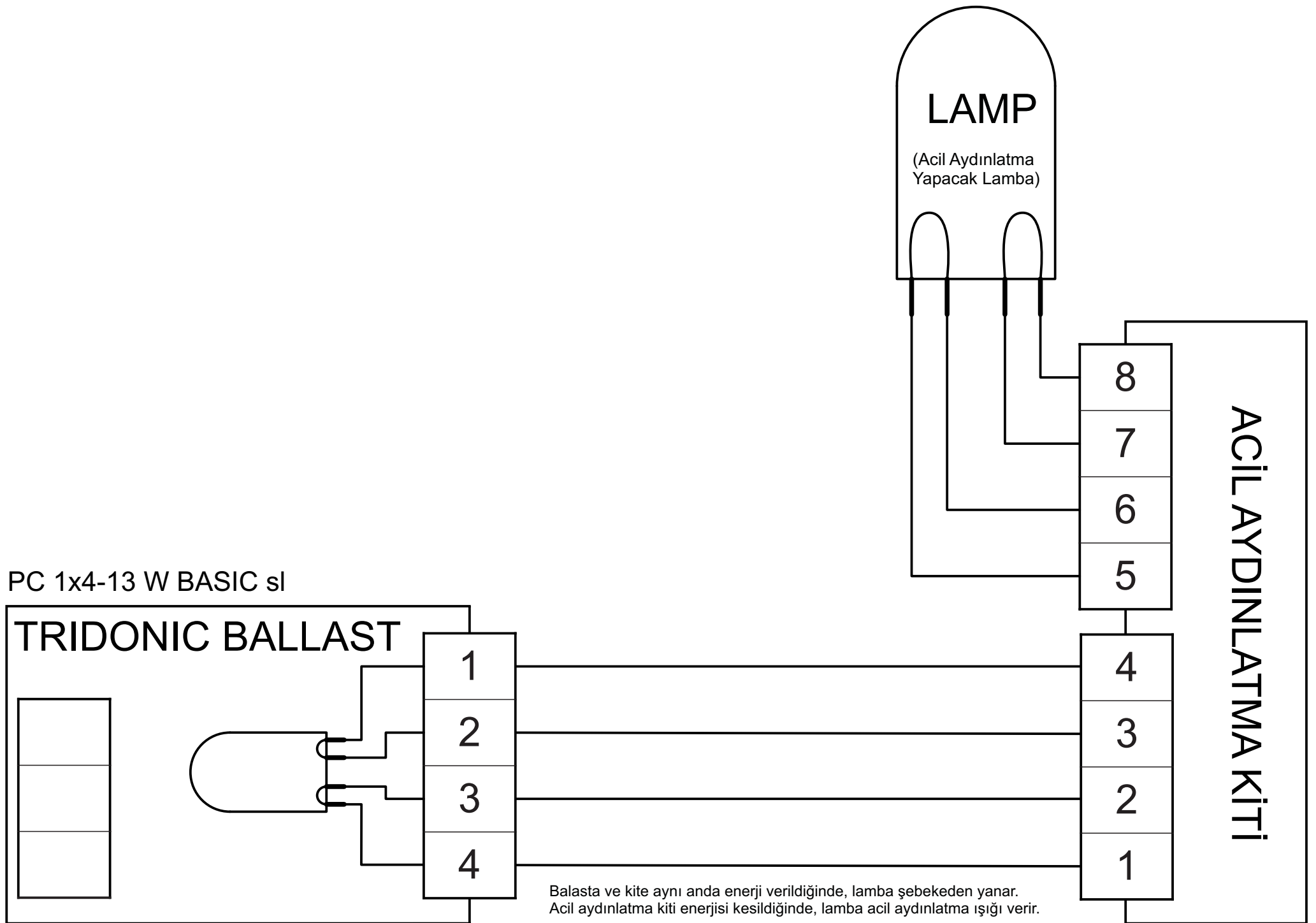

PC 1x4-13 W BASIC

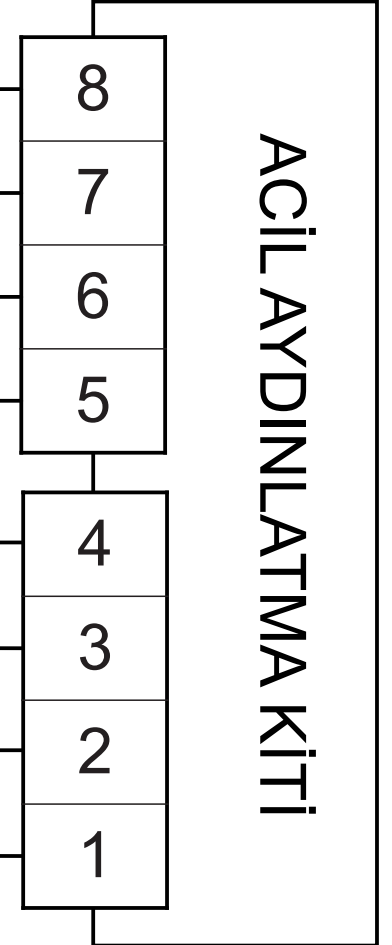
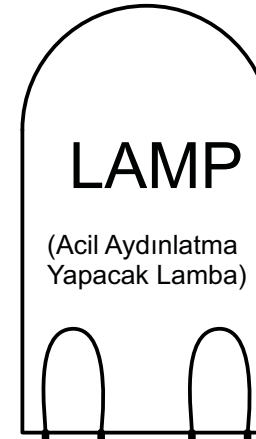
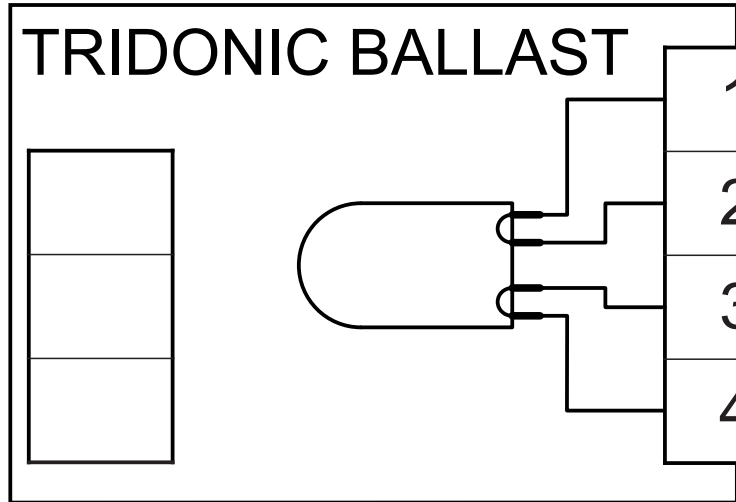

Balasta ve kite aynı anda enerji verildiğinde, lamba şebekeden yanar.  
Acil aydınlatma kiti enerjisi kesildiğinde, lamba acil aydınlatma ışığı verir.

PC 1x5-16 W BASIC sl

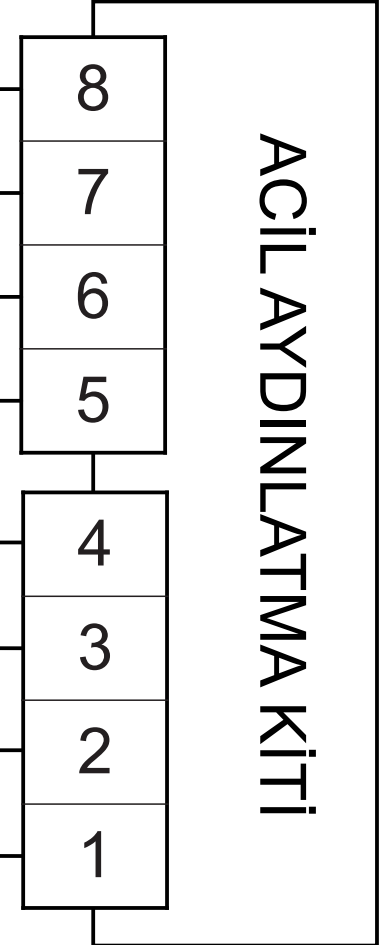
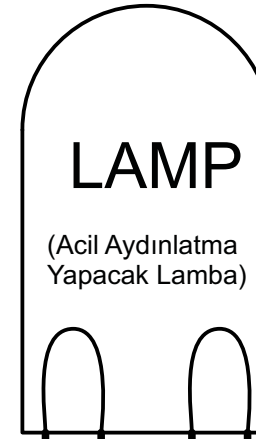
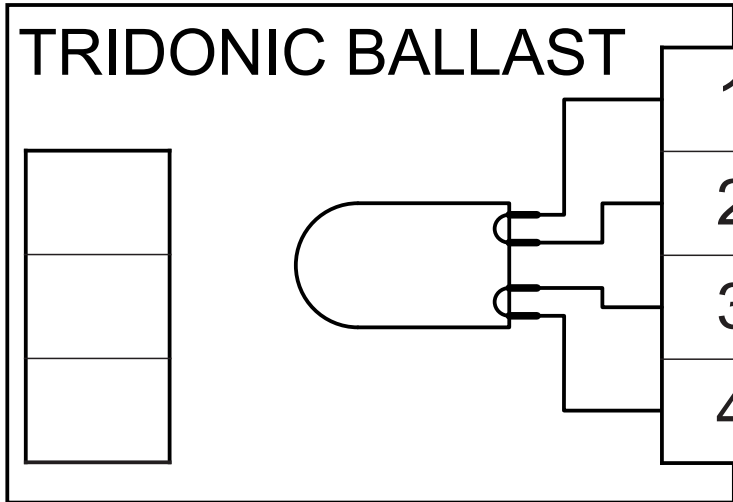

Balasta ve kite aynı anda enerji verildiğinde, lamba şebekeden yanar.  
Acil aydınlatma kiti enerjisi kesildiğinde, lamba acil aydınlatma ışığı verir.

PC 1x5-16 W BASIC

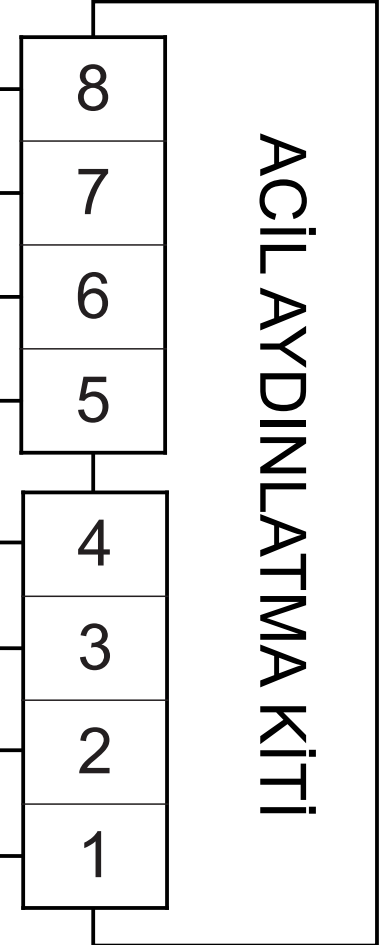
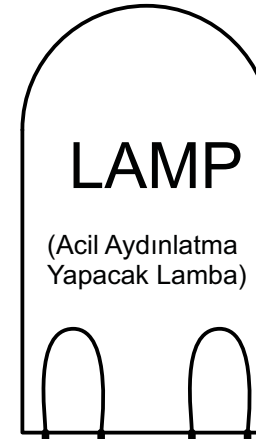
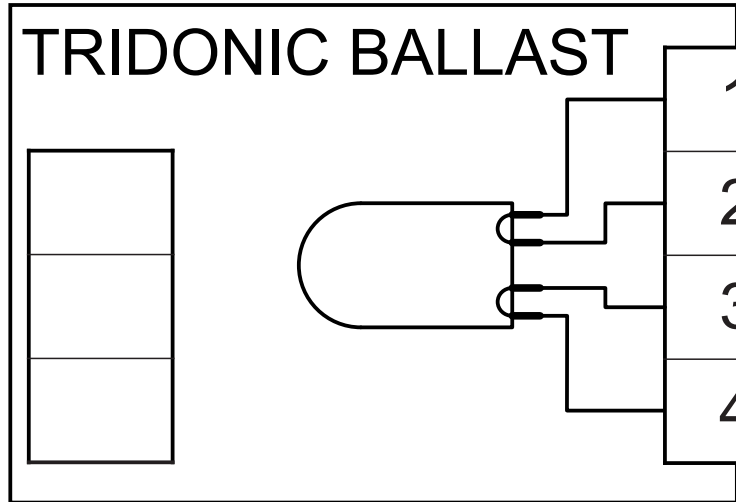

Balasta ve kite aynı anda enerji verildiğinde, lamba şebekeden yanar.  
Acil aydınlatma kiti enerjisi kesildiğinde, lamba acil aydınlatma ışığı verir.

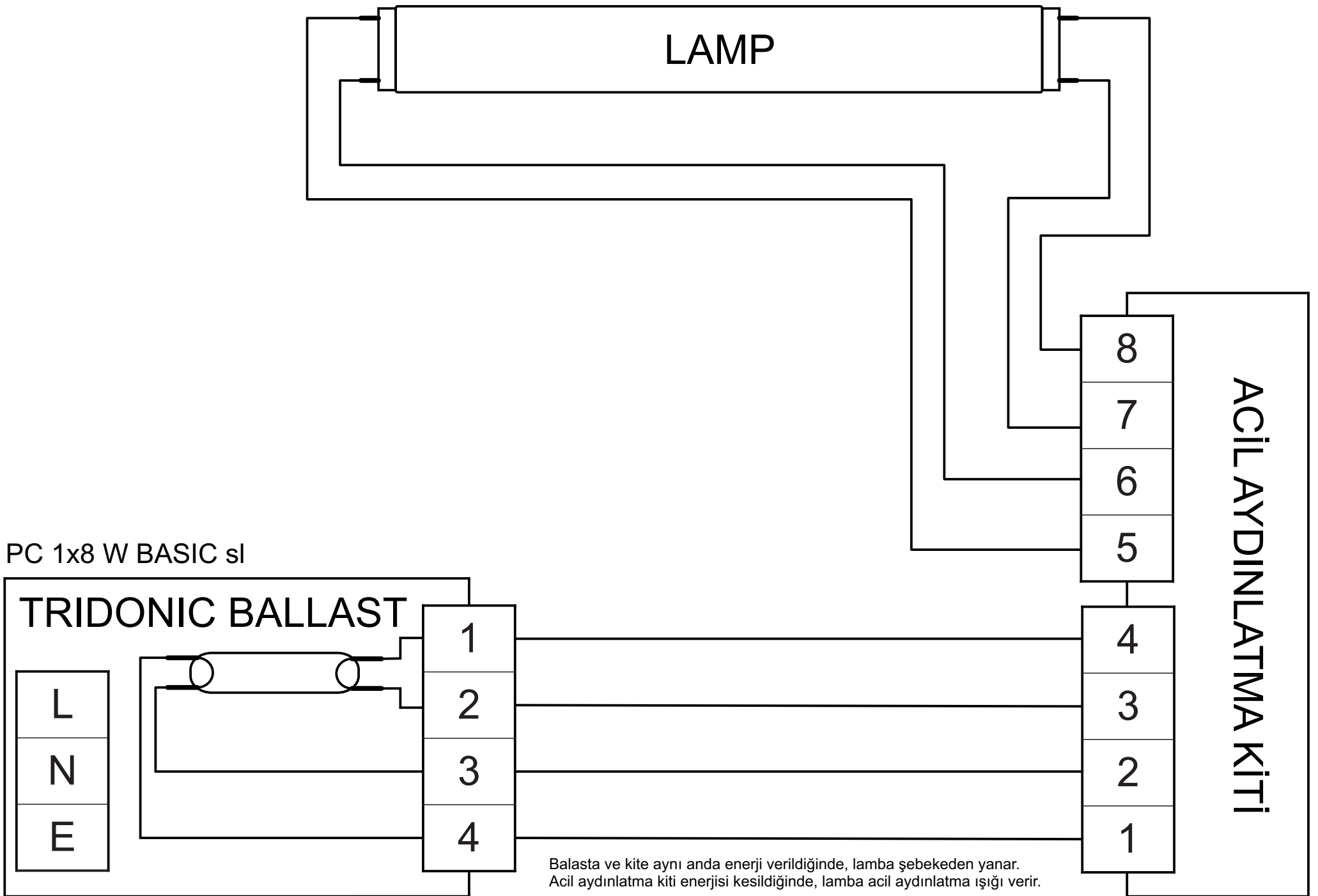



LAMP

ACIL AYDINLATMA KİTİ

PC 1x14 T5 TEC Ip

TRIDONIC BALLAST

L

N

E

16

15

14

13

8

7

6

5

4

3

2

1

Balasta ve kite aynı anda enerji verildiğinde, lamba şebekeden yanar.  
Acil aydınlatma kiti enerjisi kesildiğinde, lamba acil aydınlatma ışığı verir.

PC 1x14-21 W BASIC sl

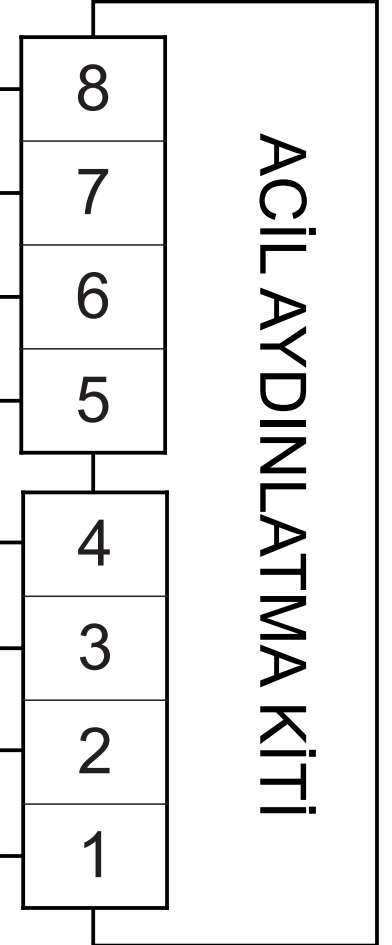
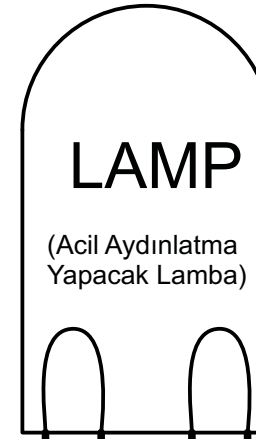
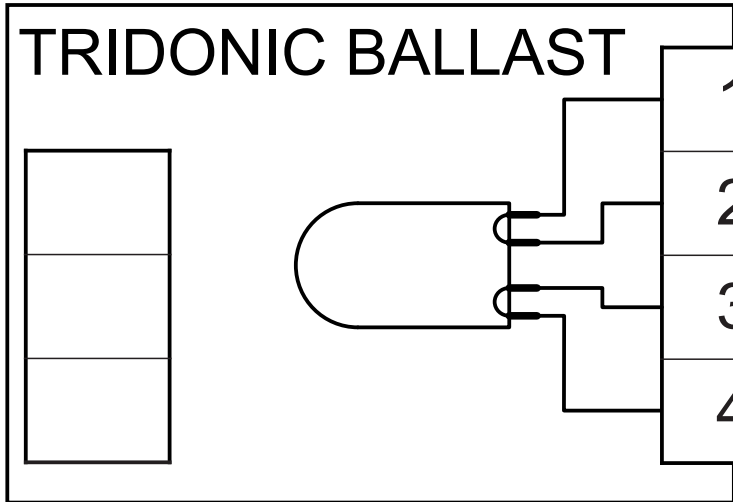

Balasta ve kite aynı anda enerji verildiğinde, lamba şebekeden yanar.  
Acil aydınlatma kiti enerjisi kesildiğinde, lamba acil aydınlatma ışığı verir.

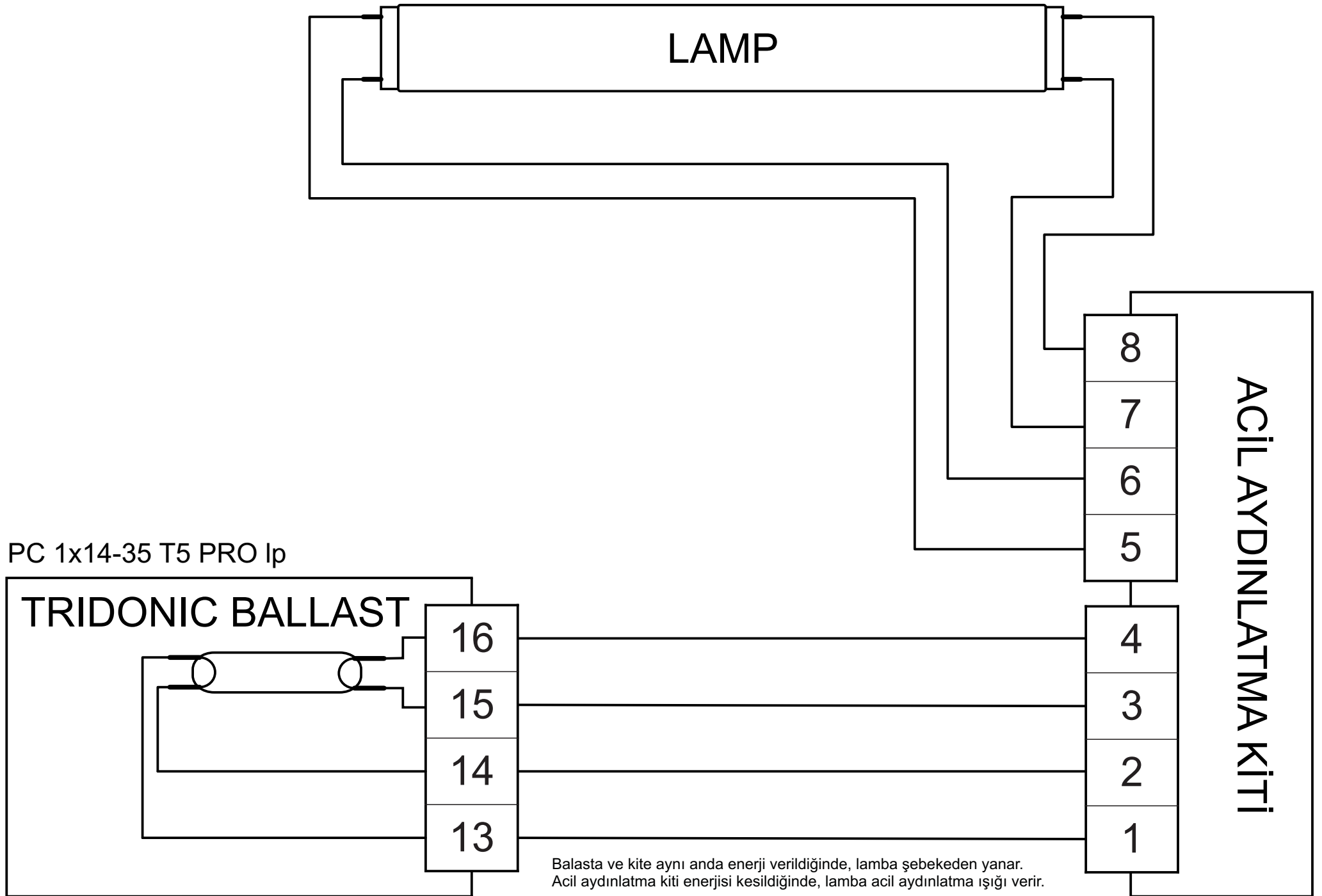

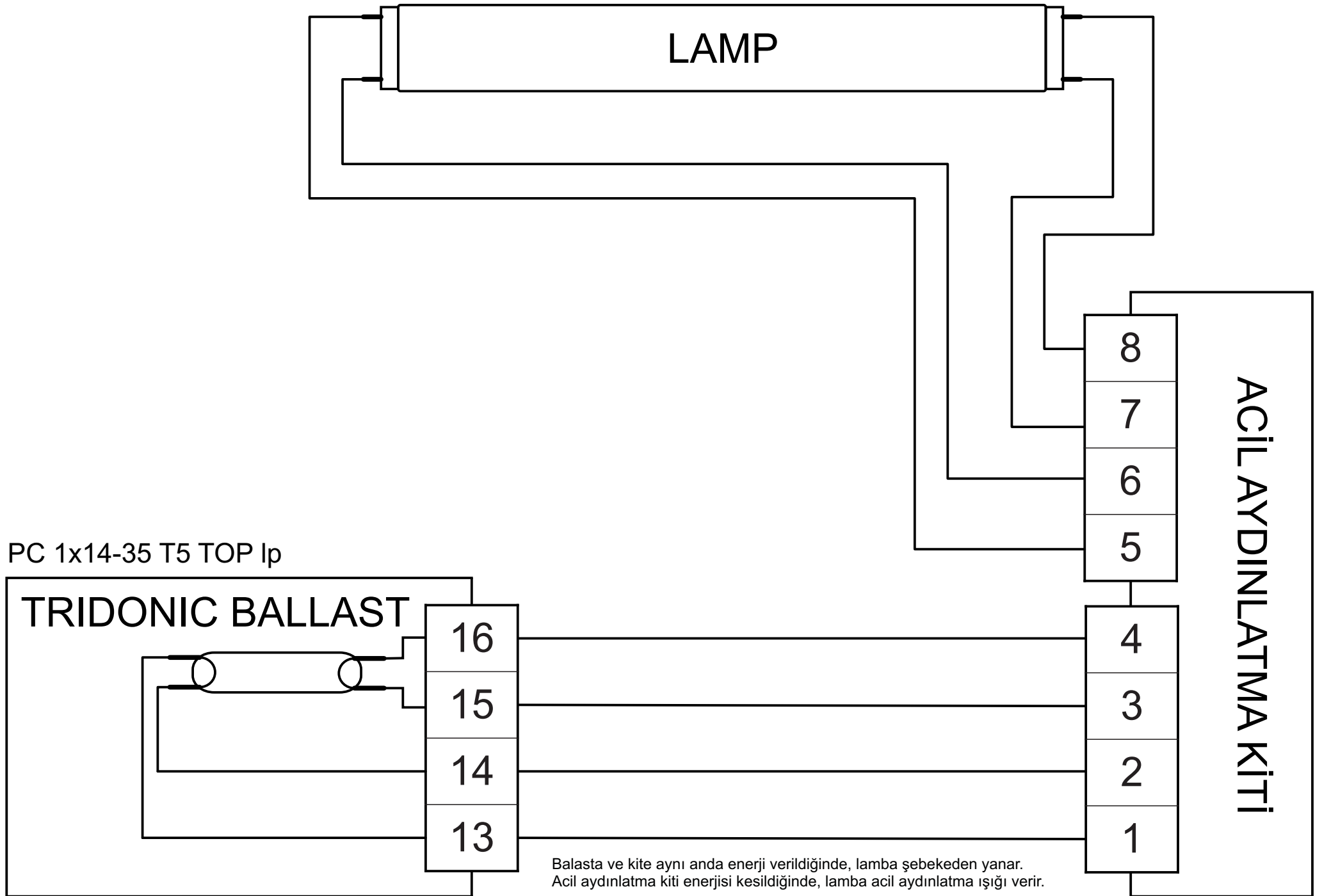

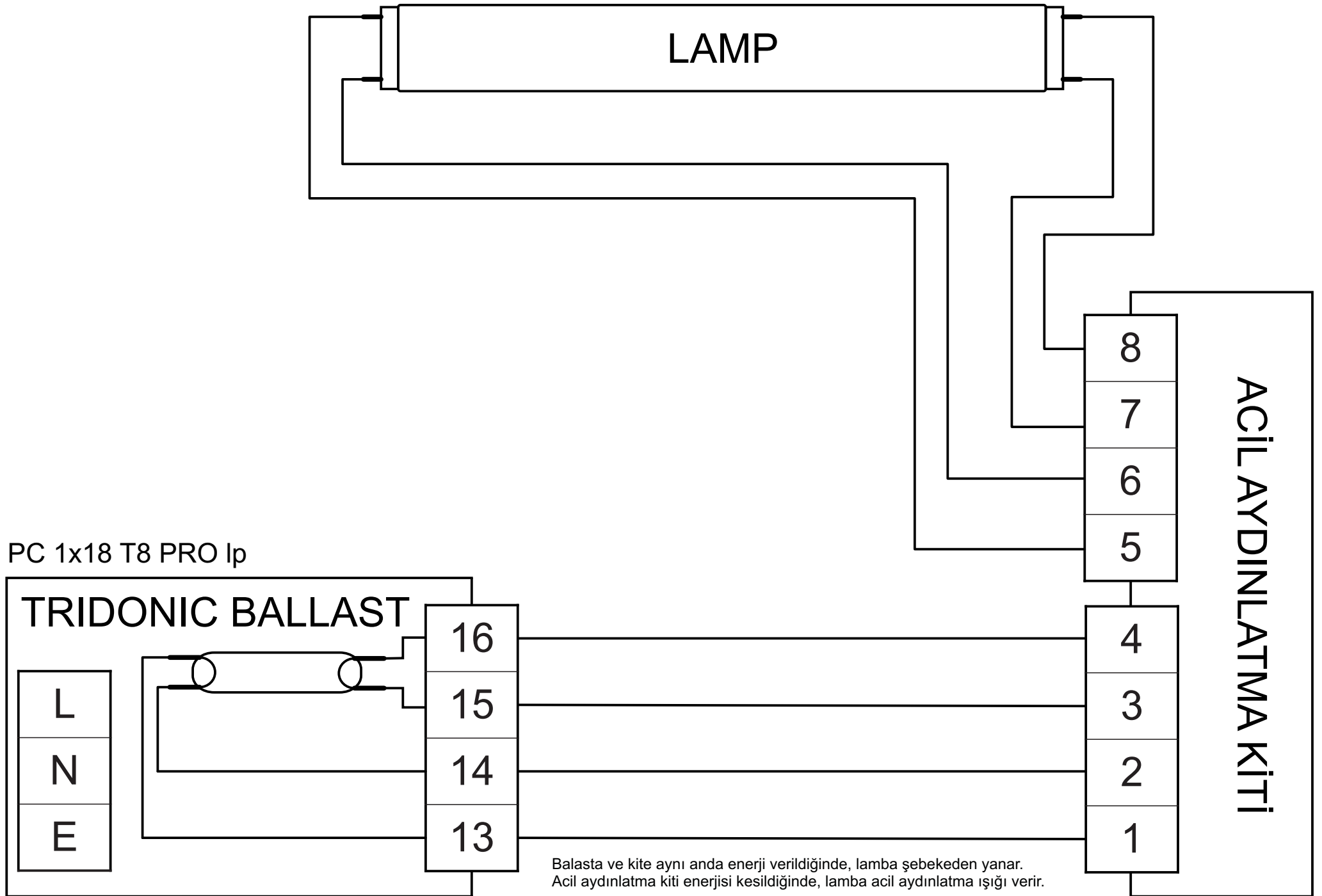

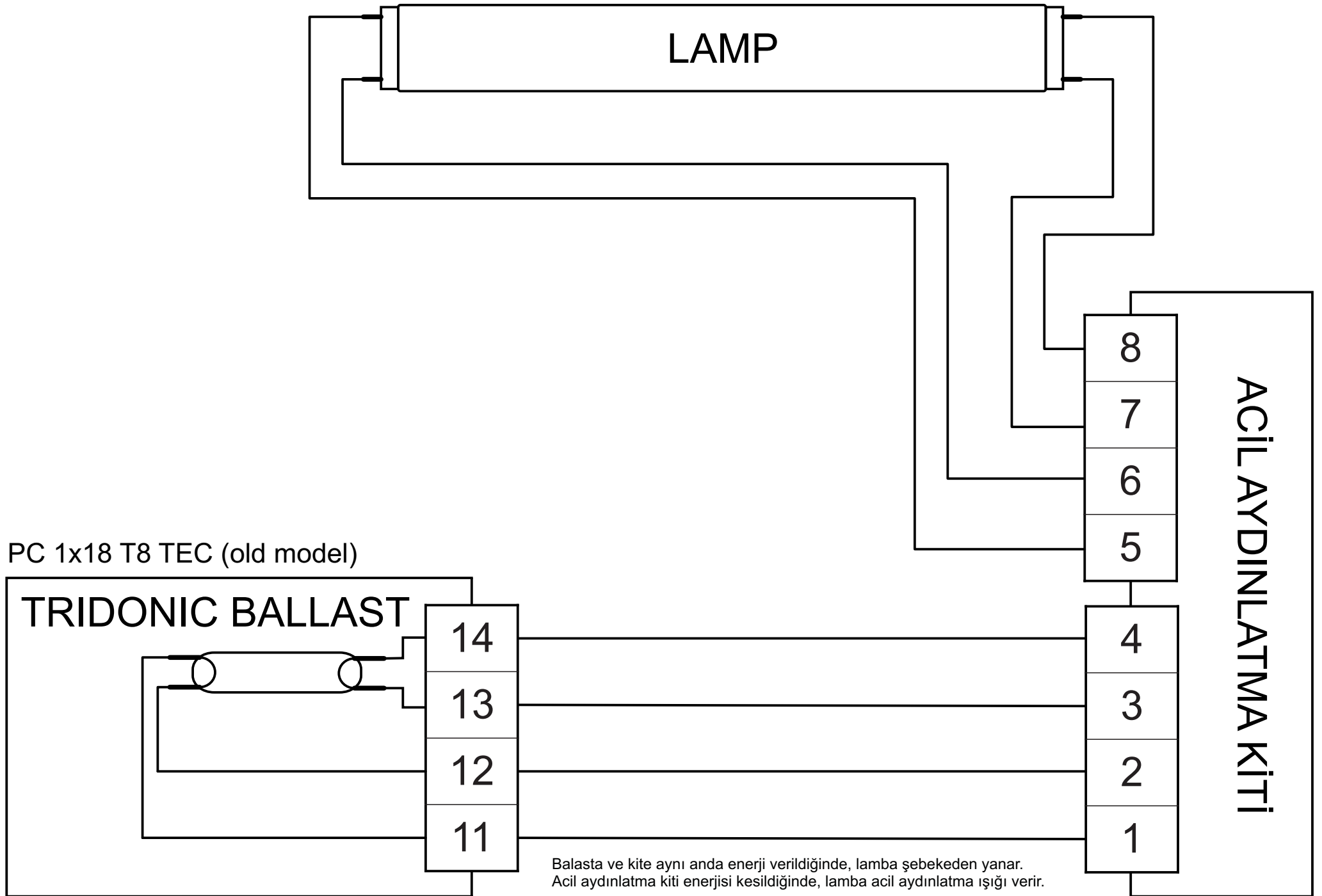

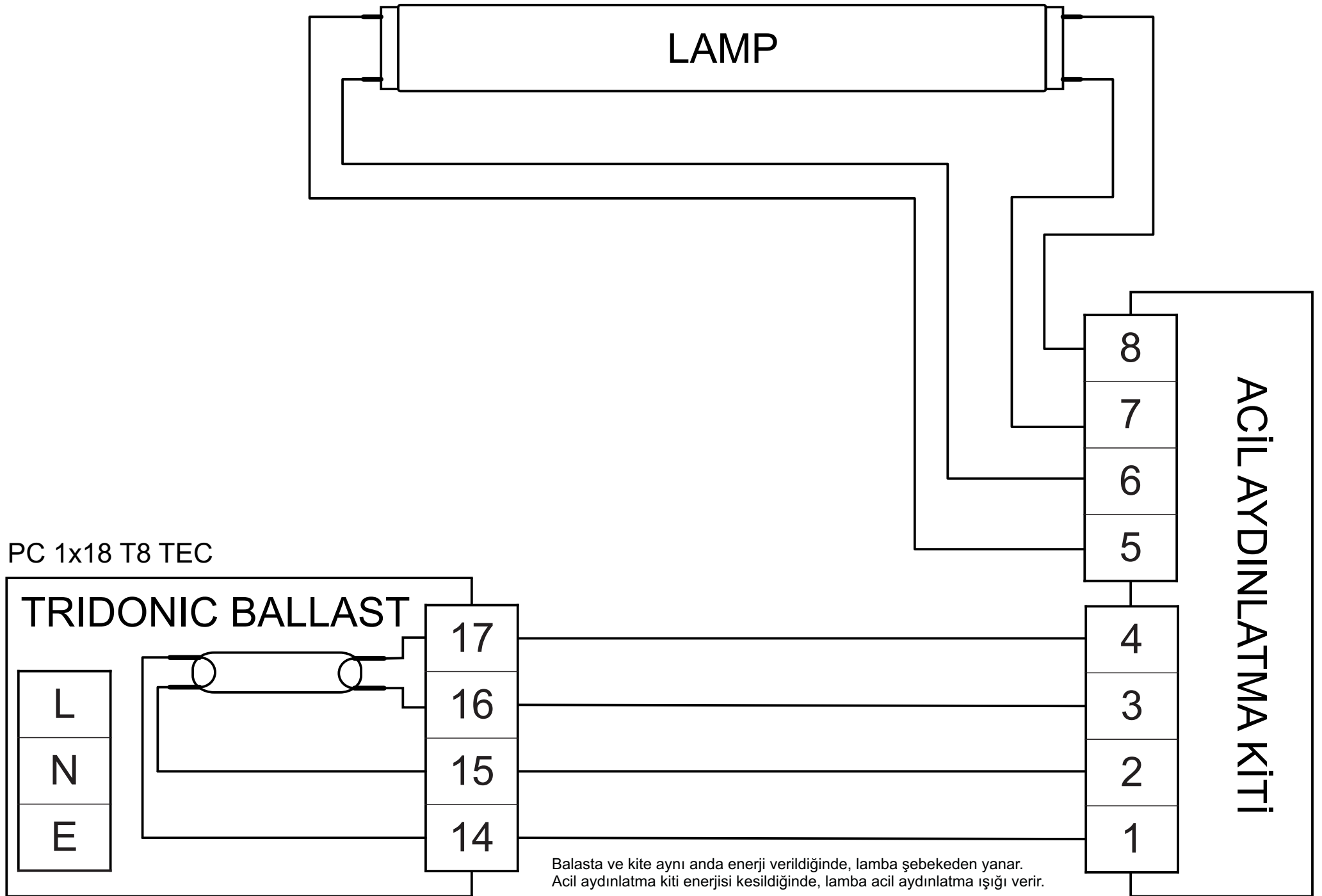

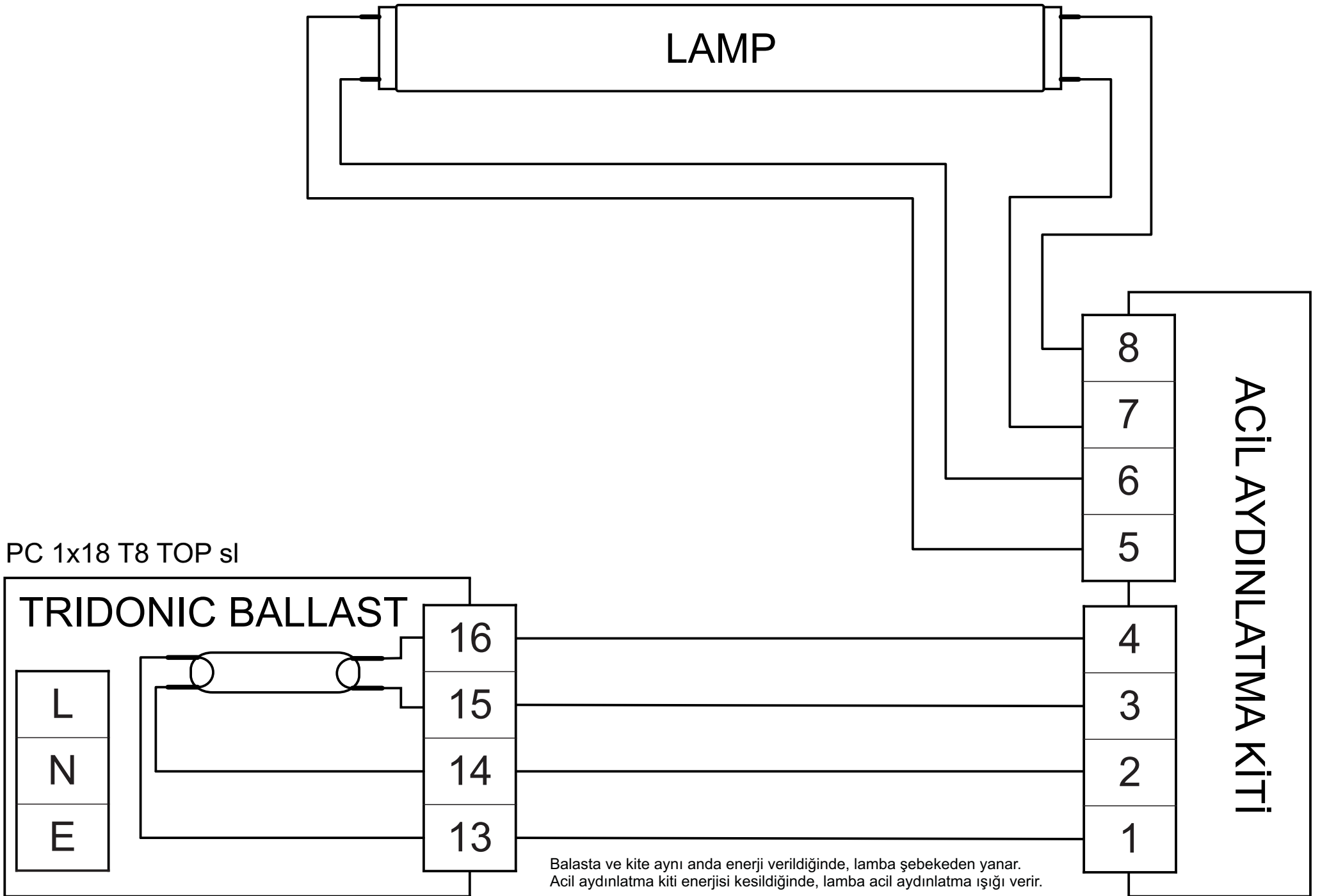



PC 1x18 TC TOP sr

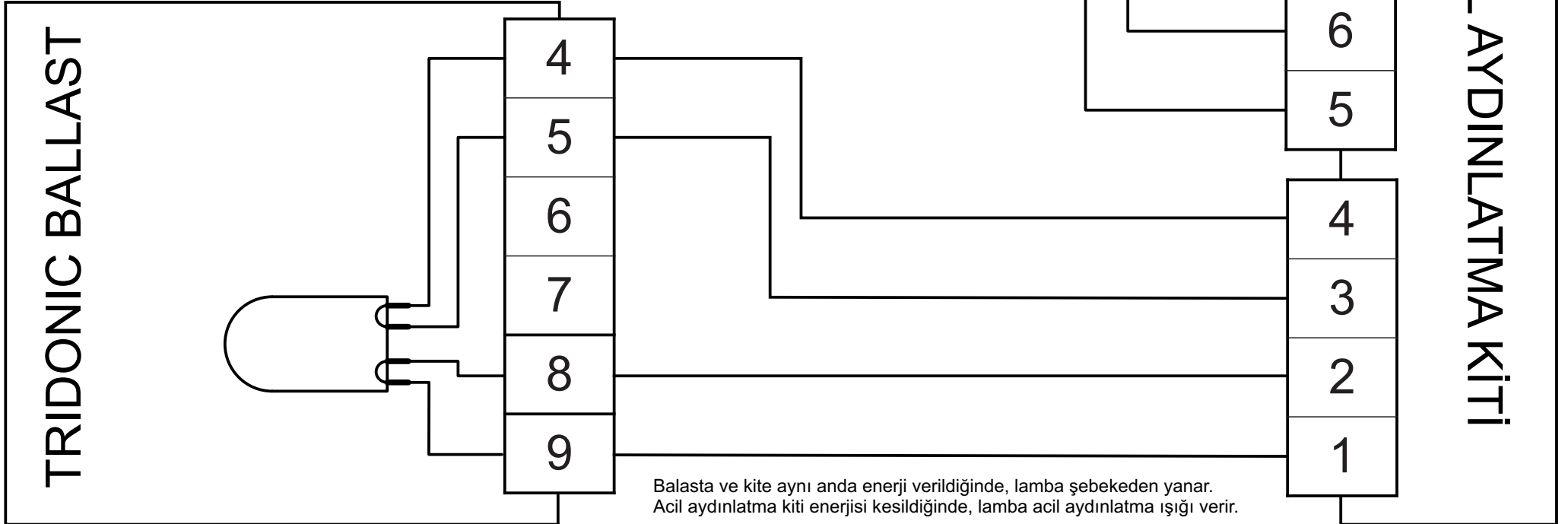

PC 1x18 TC TOP

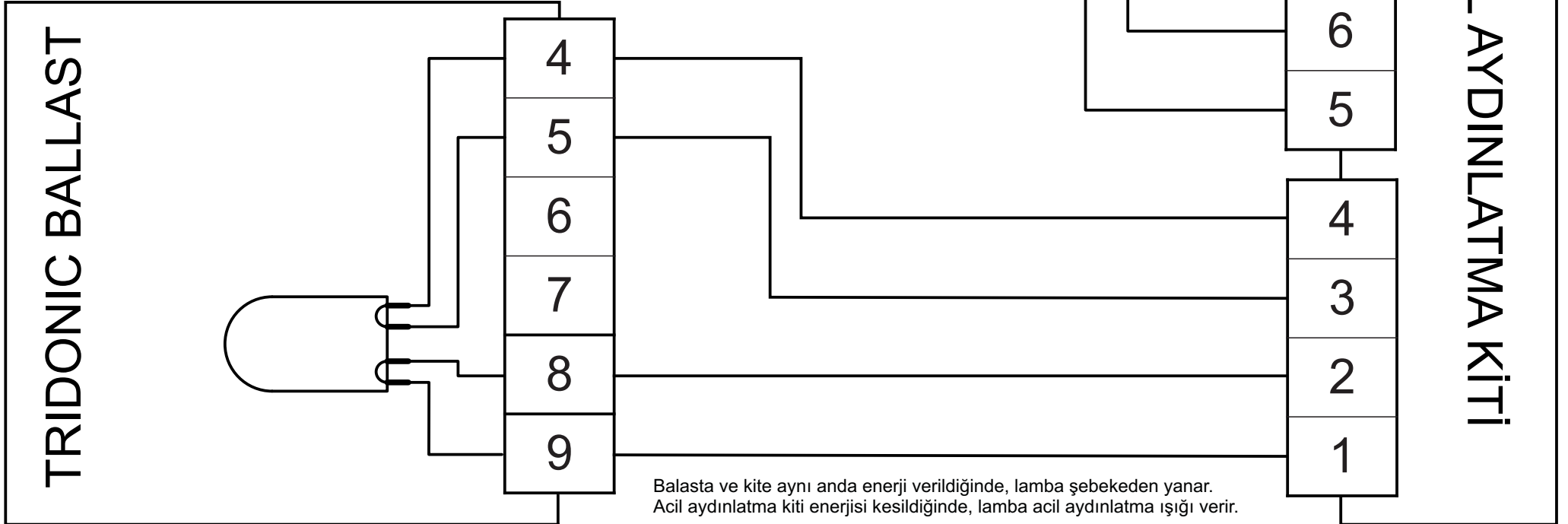

PC 1x18 W BASIC s1

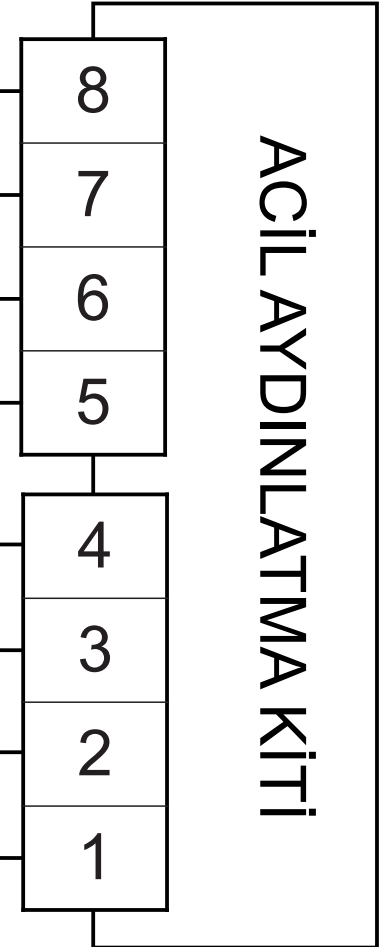
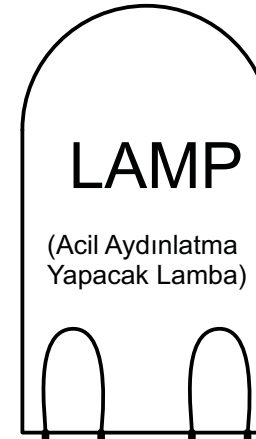
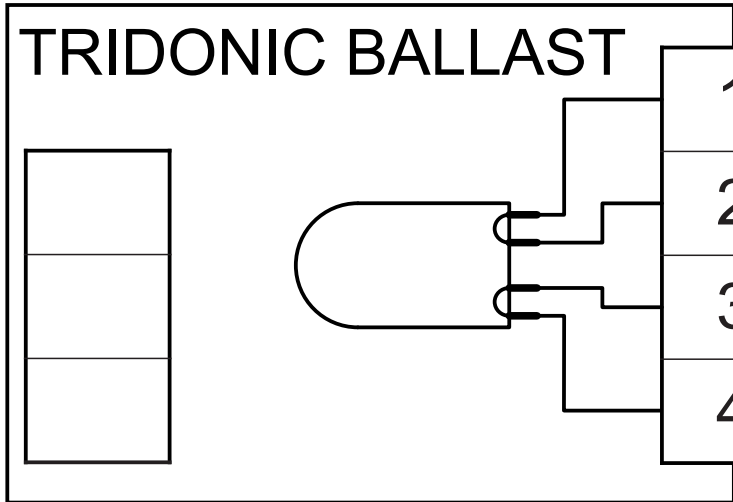

Balasta ve kite aynı anda enerji verildiğinde, lamba şebekeden yanar.  
Acil aydınlatma kiti enerjisi kesildiğinde, lamba acil aydınlatma ışığı verir.

PC 1x18 W BASIC

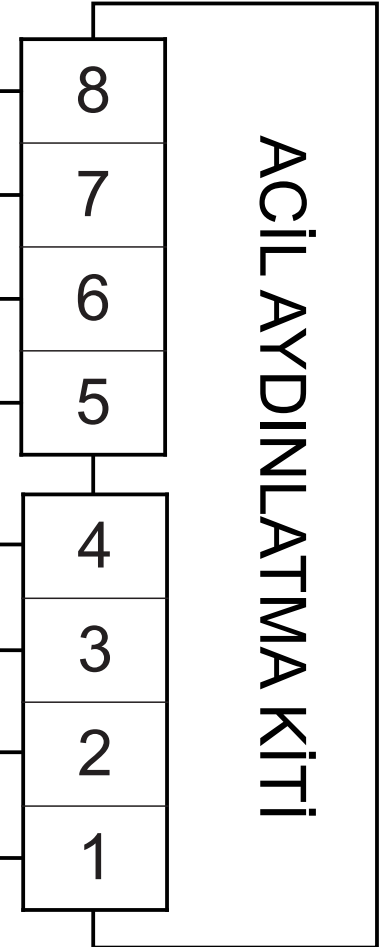
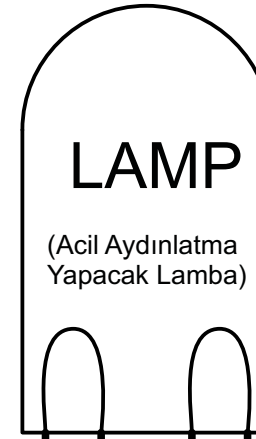
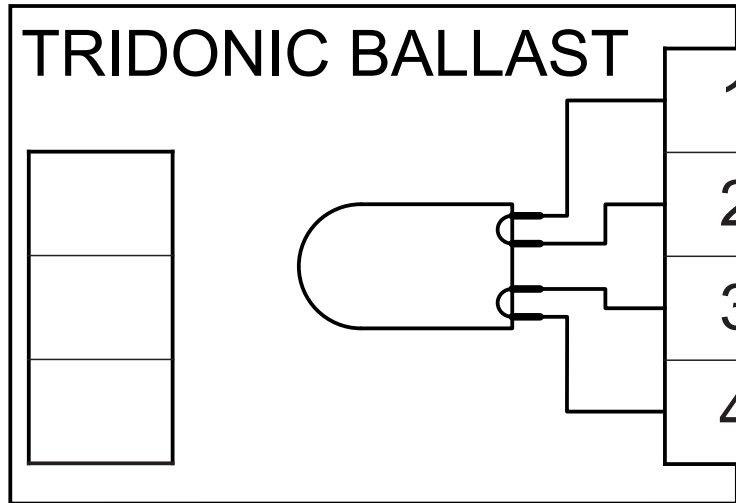

Balasta ve kite aynı anda enerji verildiğinde, lamba şebekeden yanar.  
Acil aydınlatma kiti enerjisi kesildiğinde, lamba acil aydınlatma ışığı verir.

PC 1x18-24 W BASIC sl

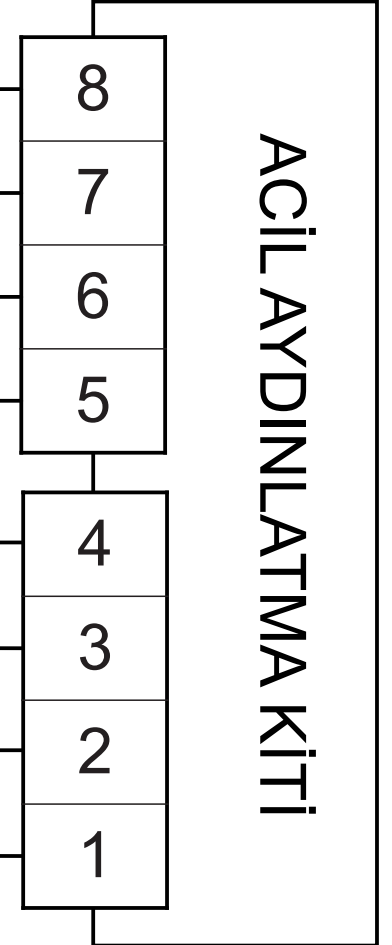
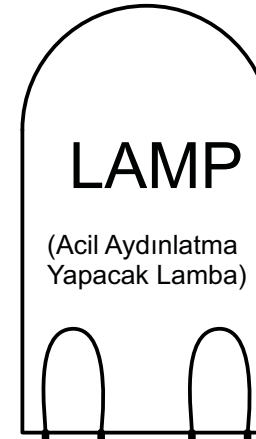
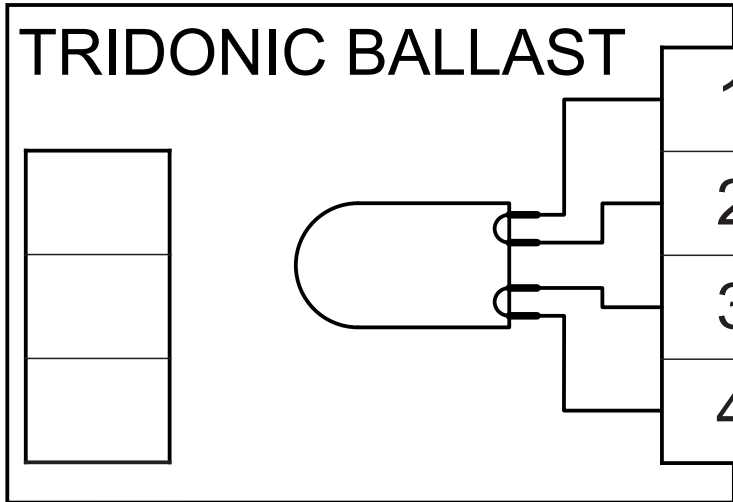

Balasta ve kite aynı anda enerji verildiğinde, lamba şebekeden yanar.  
Acil aydınlatma kiti enerjisi kesildiğinde, lamba acil aydınlatma ışığı verir.

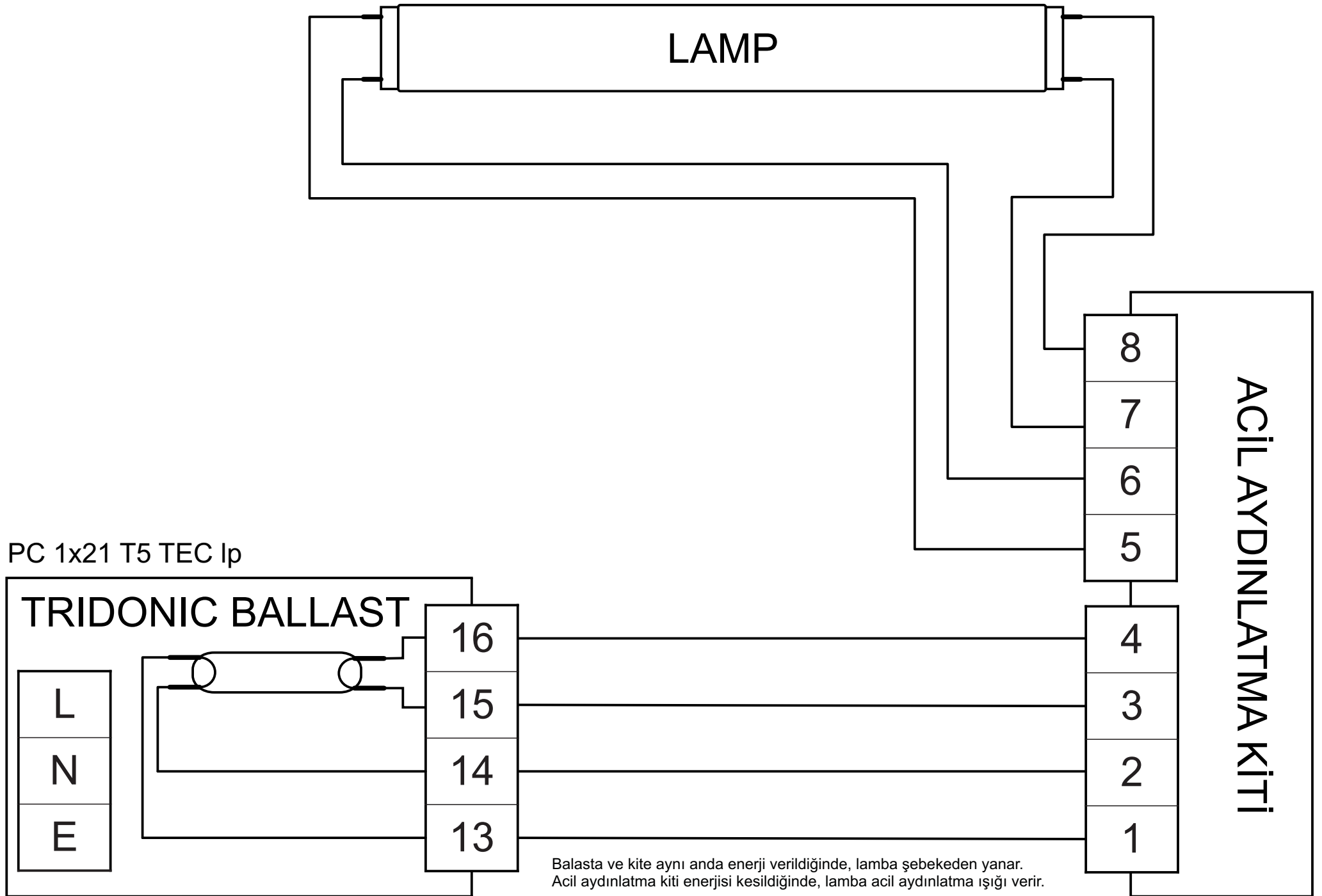

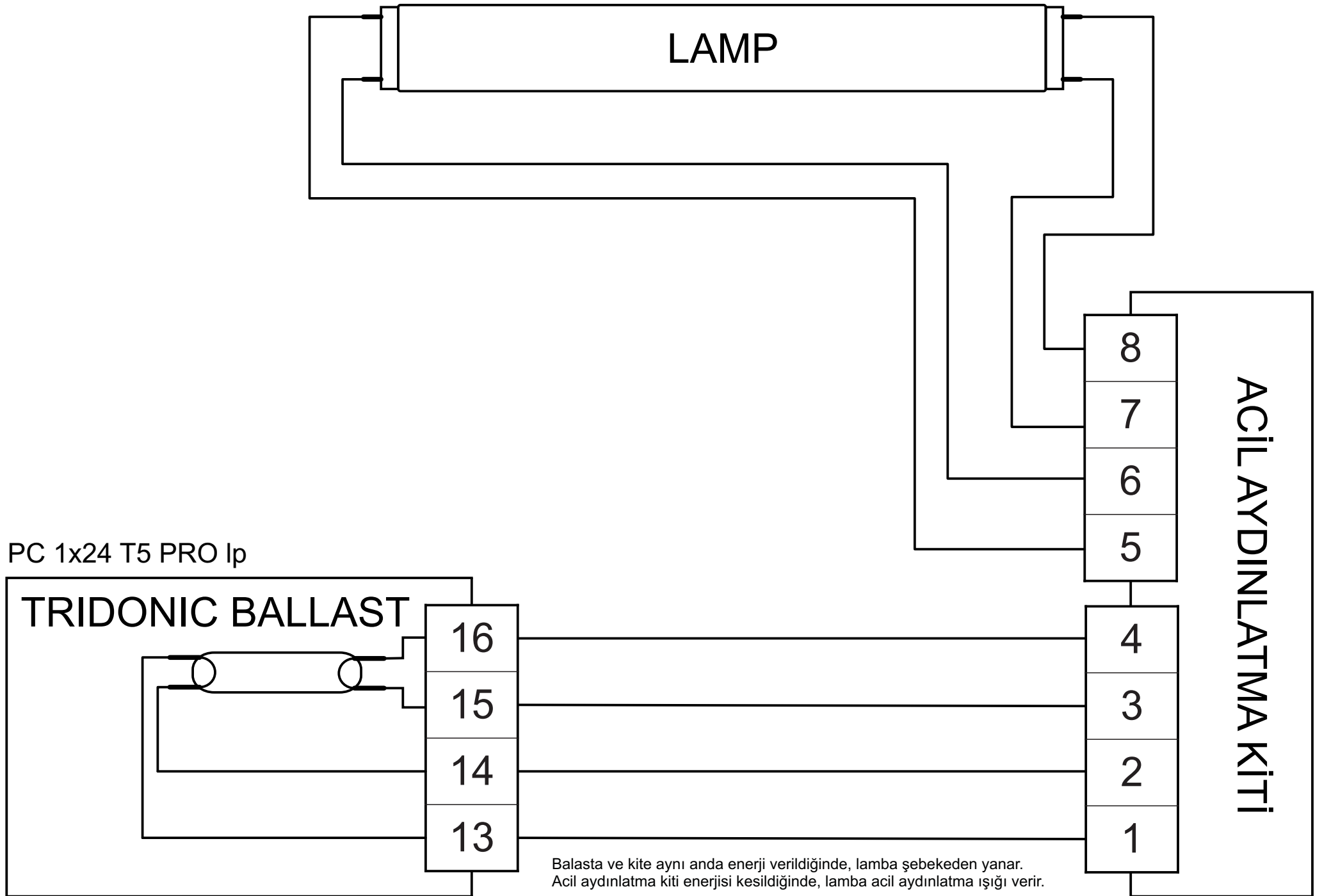

Balasta ve kite aynı anda enerji verildiğinde, lamba şebekeden yanar.  
Acil aydınlatma kiti enerjisi kesildiğinde, lamba acil aydınlatma ışığı verir.

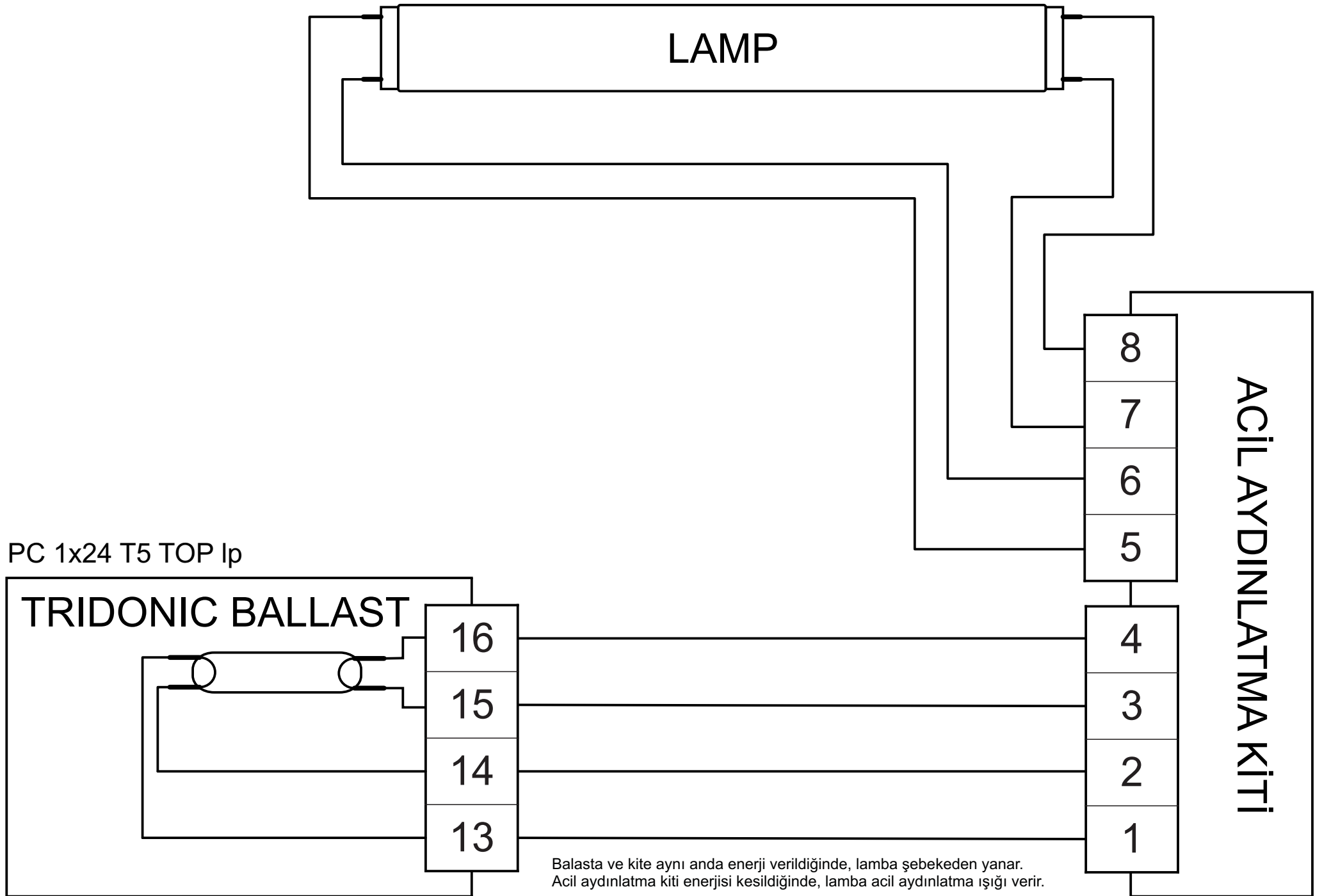



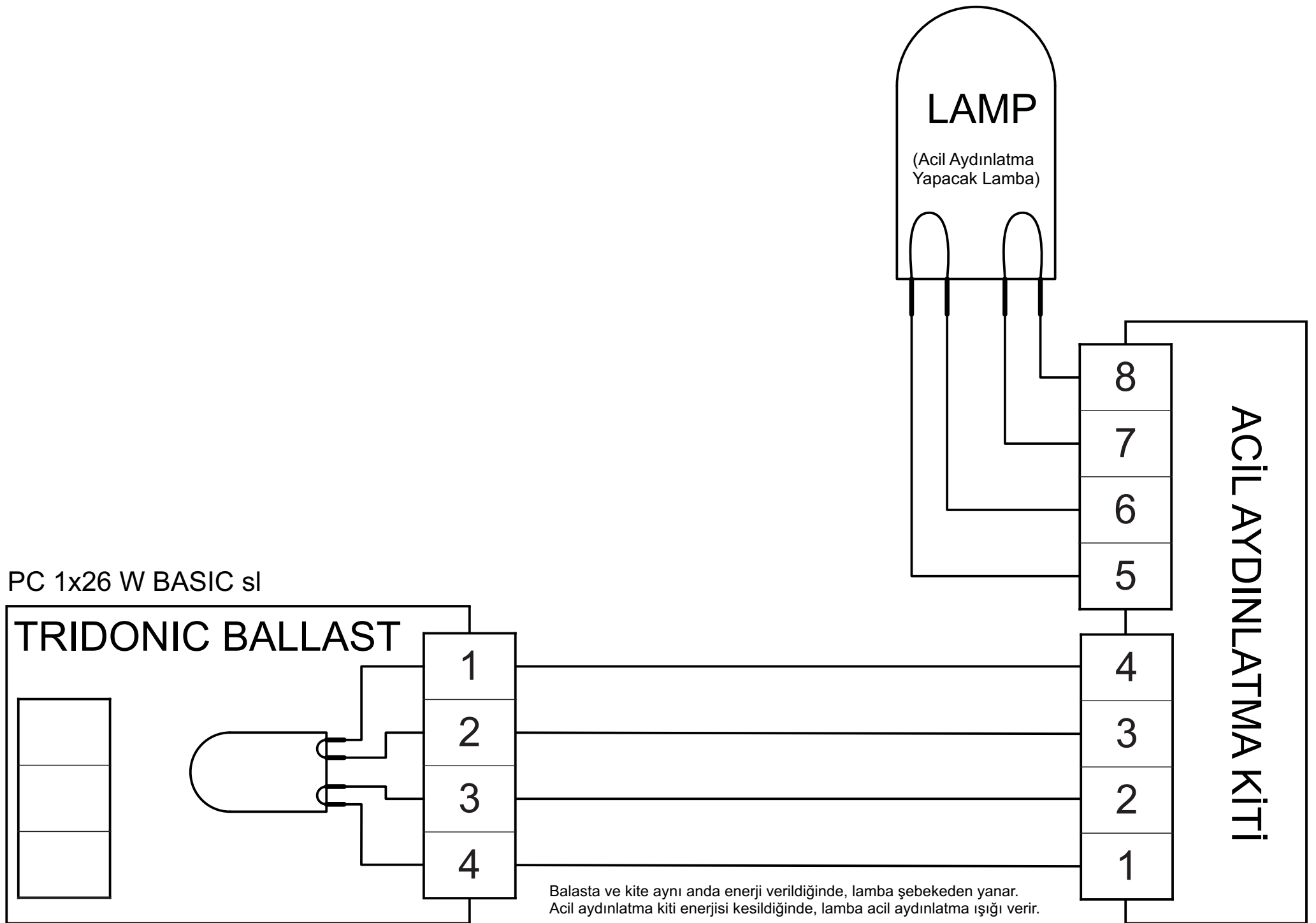

Balasta ve kite aynı anda enerji verildiğinde, lamba şebekeden yanar.  
Acil aydınlatma kiti enerjisi kesildiğinde, lamba acil aydınlatma ışığı verir.

PC 1x26 W BASIC

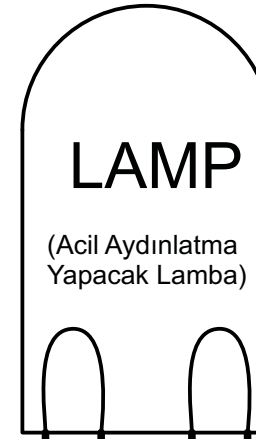
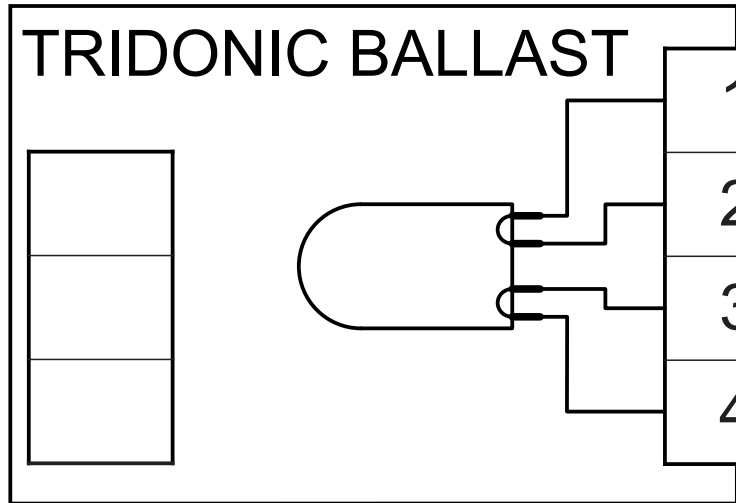

Balasta ve kite aynı anda enerji verildiğinde, lamba şebekeden yanar.  
Acil aydınlatma kiti enerjisi kesildiğinde, lamba acil aydınlatma ışığı verir.

PC 1x26-42 TC TOP sr

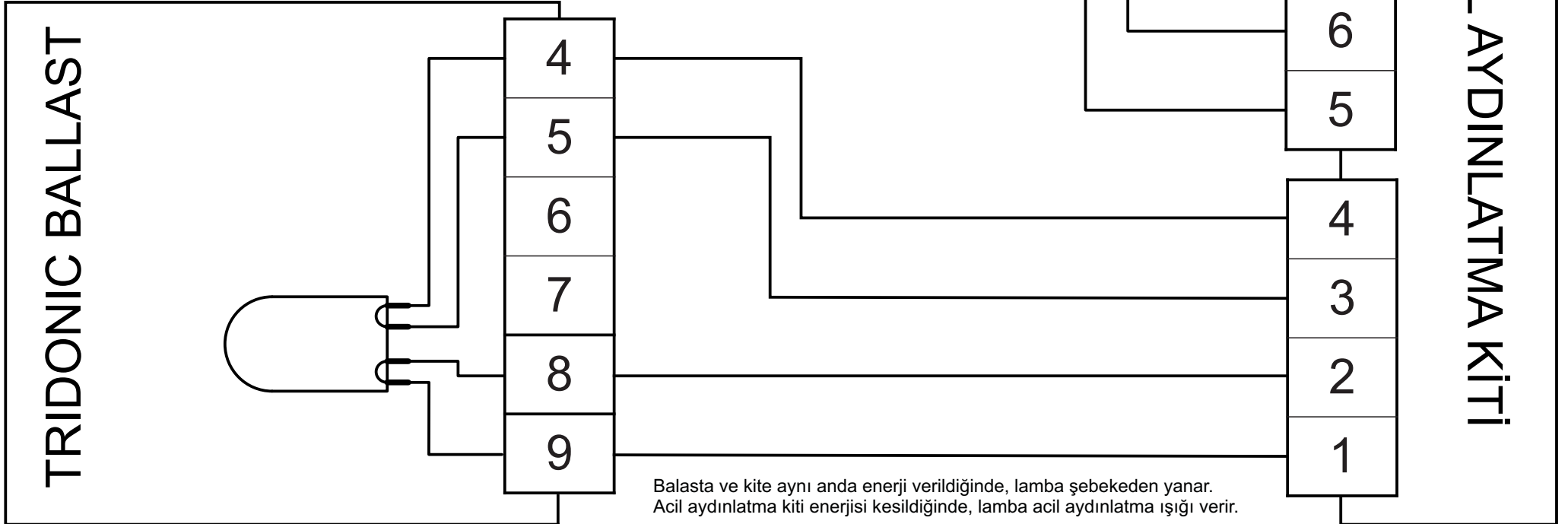

Balasta ve kite aynı anda enerji verildiğinde, lamba şebekeden yanar.  
Acil aydınlatma kiti enerjisi kesildiğinde, lamba acil aydınlatma ışığı verir.

PC 1x26-42 TC TOP

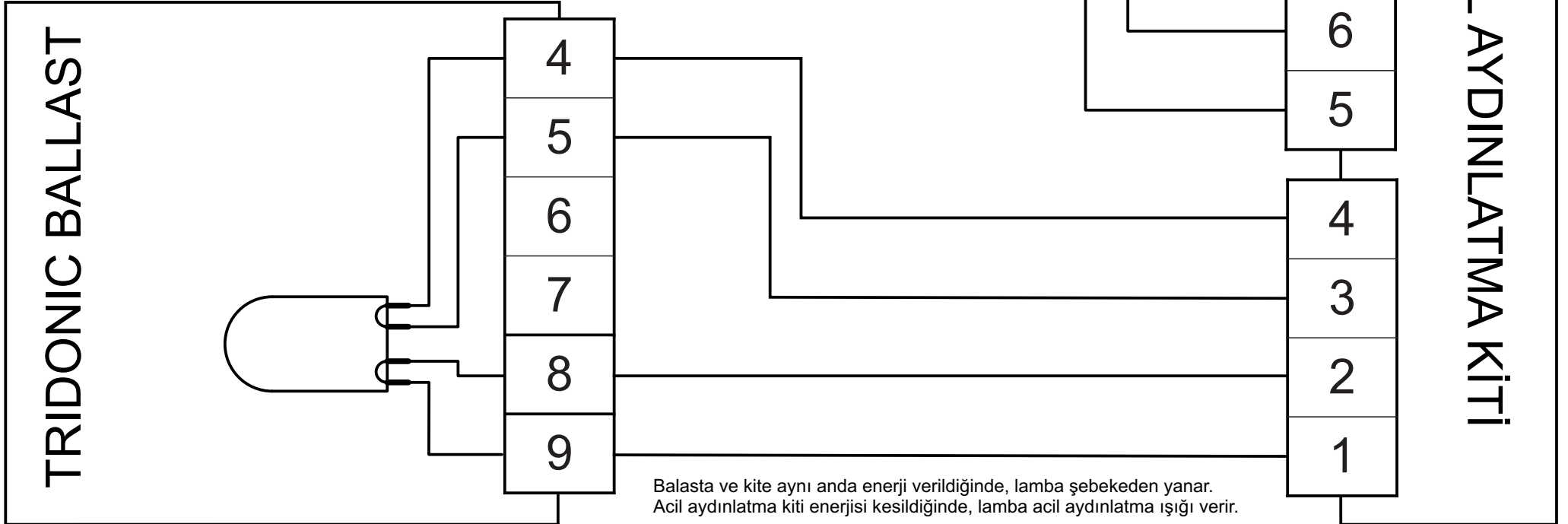

Balasta ve kite aynı anda enerji verildiğinde, lamba şebekeden yanar.  
Acil aydınlatma kiti enerjisi kesildiğinde, lamba acil aydınlatma ışığı verir.

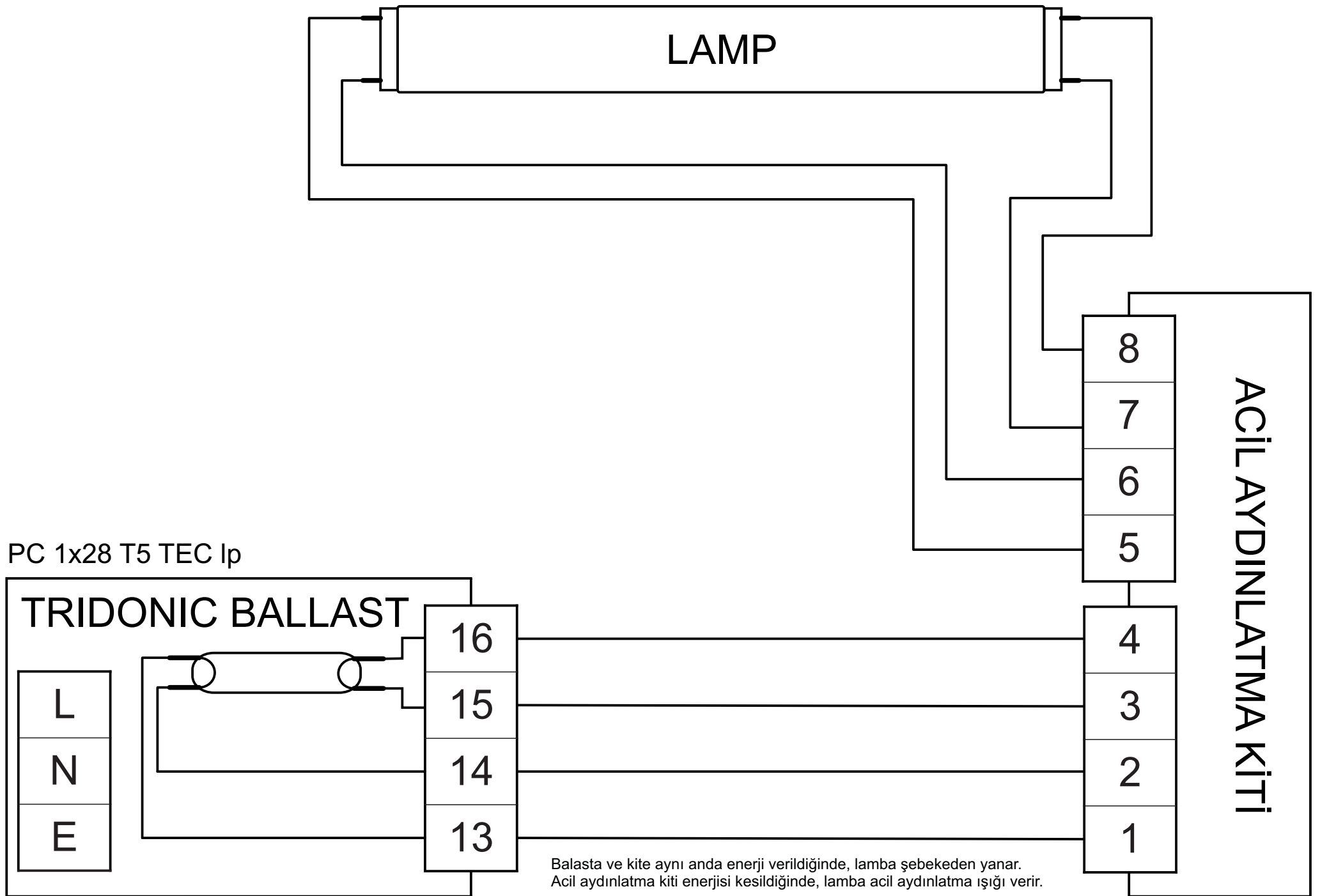

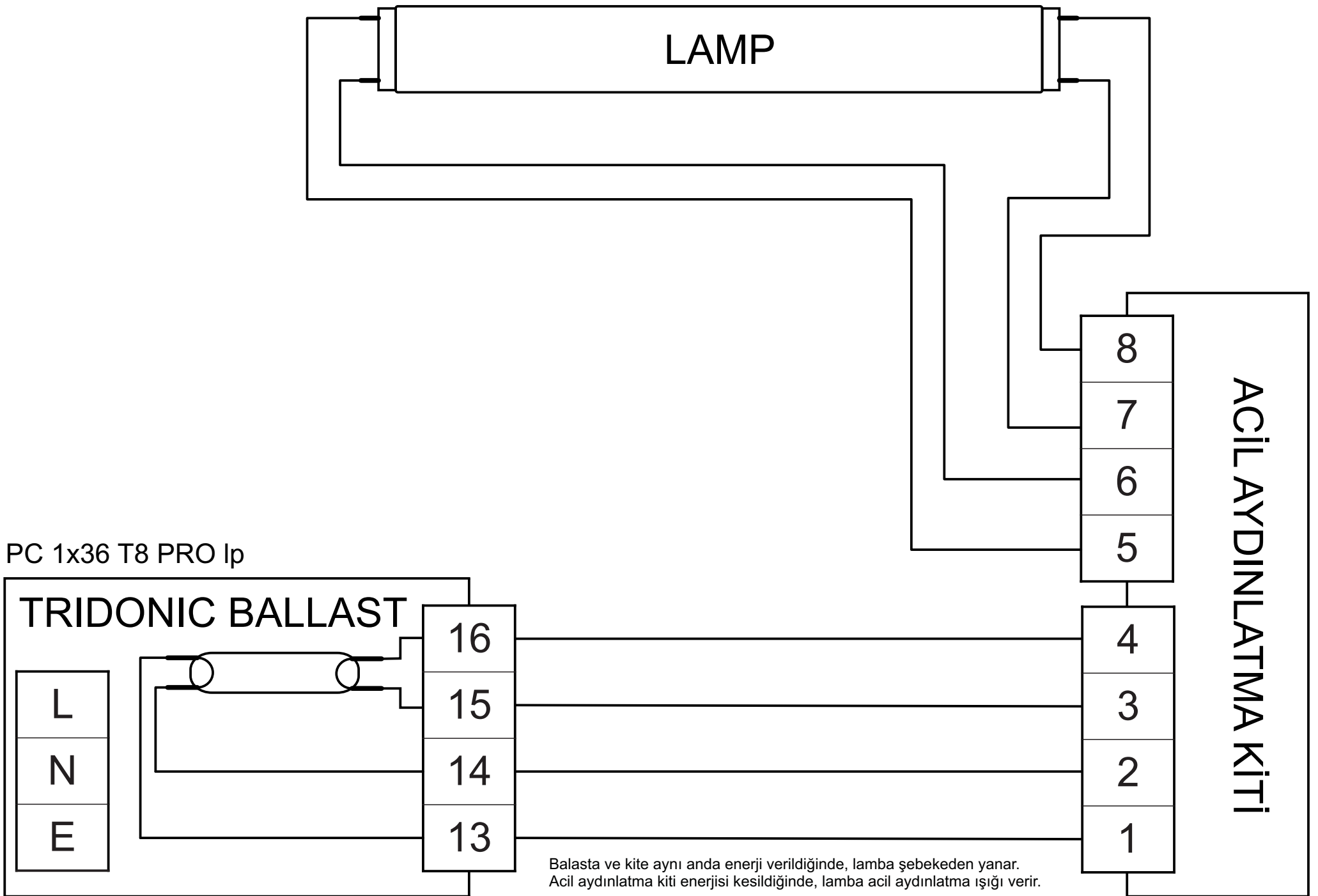

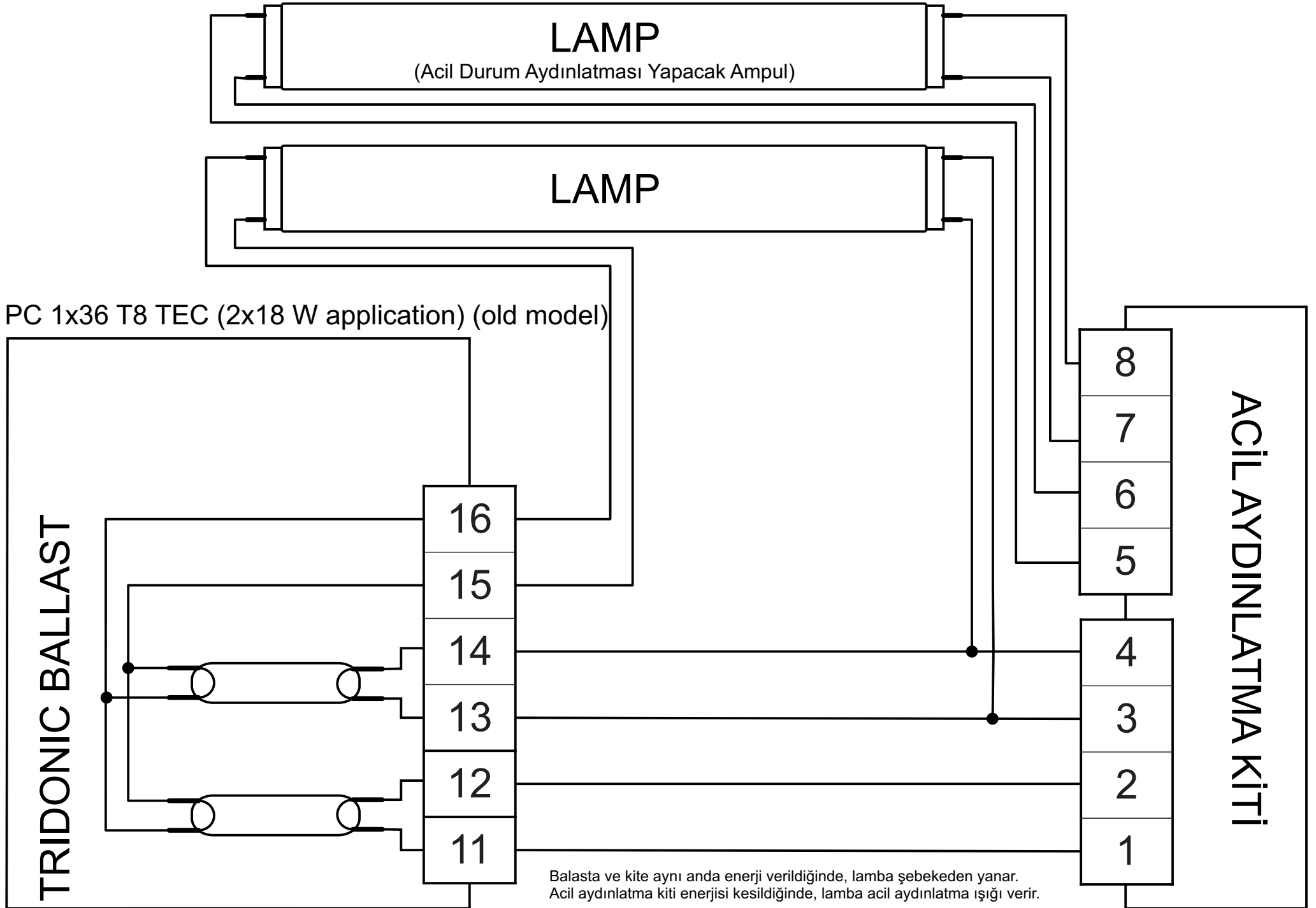

Balasta ve kite aynı anda enerji verildiğinde, lamba şebekeden yanar.  
Acil aydınlatma kiti enerjisi kesildiğinde, lamba acil aydınlatma ışığı verir.

LAMP

PC 1x36 T8 TEC (old model)

TRIDONIC BALLAST

16

15

14

13

12

11

8

7

6

5

4

3

2

1

ACIL AYDINLATMA KITI

Balasta ve kite aynı anda enerji verildiğinde, lamba şebekeden yanar.  
Acil aydınlatma kiti enerjisi kesildiğinde, lamba acil aydınlatma ışığı verir.



LAMP

PC 1x36 T8 TEC

TRIDONIC BALLAST

ACIL AYDINLATMA KİTİ

19

18

15

14

8

7

6

5

4

3

2

1

Balasta ve kite aynı anda enerji verildiğinde, lamba şebekeden yanar.  
Acil aydınlatma kiti enerjisi kesildiğinde, lamba acil aydınlatma ışığı verir.

LAMP

ACIL AYDINLATMA KİTİ

PC 1x36 T8 TOP sl

TRIDONIC BALLAST

L

N

E

16

15

14

13

8

7

6

5

4

3

2

1

Balasta ve kite aynı anda enerji verildiğinde, lamba şebekeden yanar.  
Acil aydınlatma kiti enerjisi kesildiğinde, lamba acil aydınlatma ışığı verir.

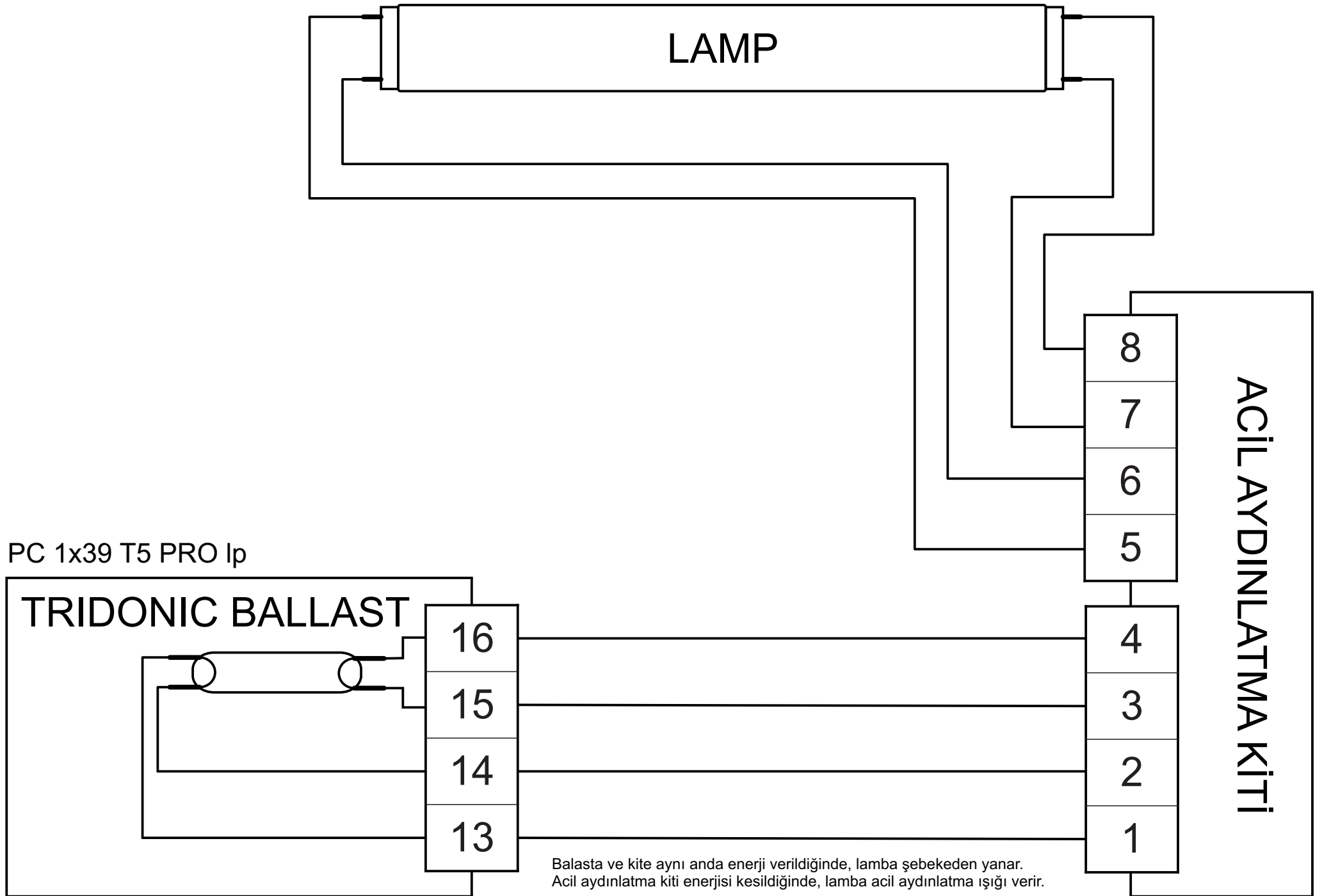

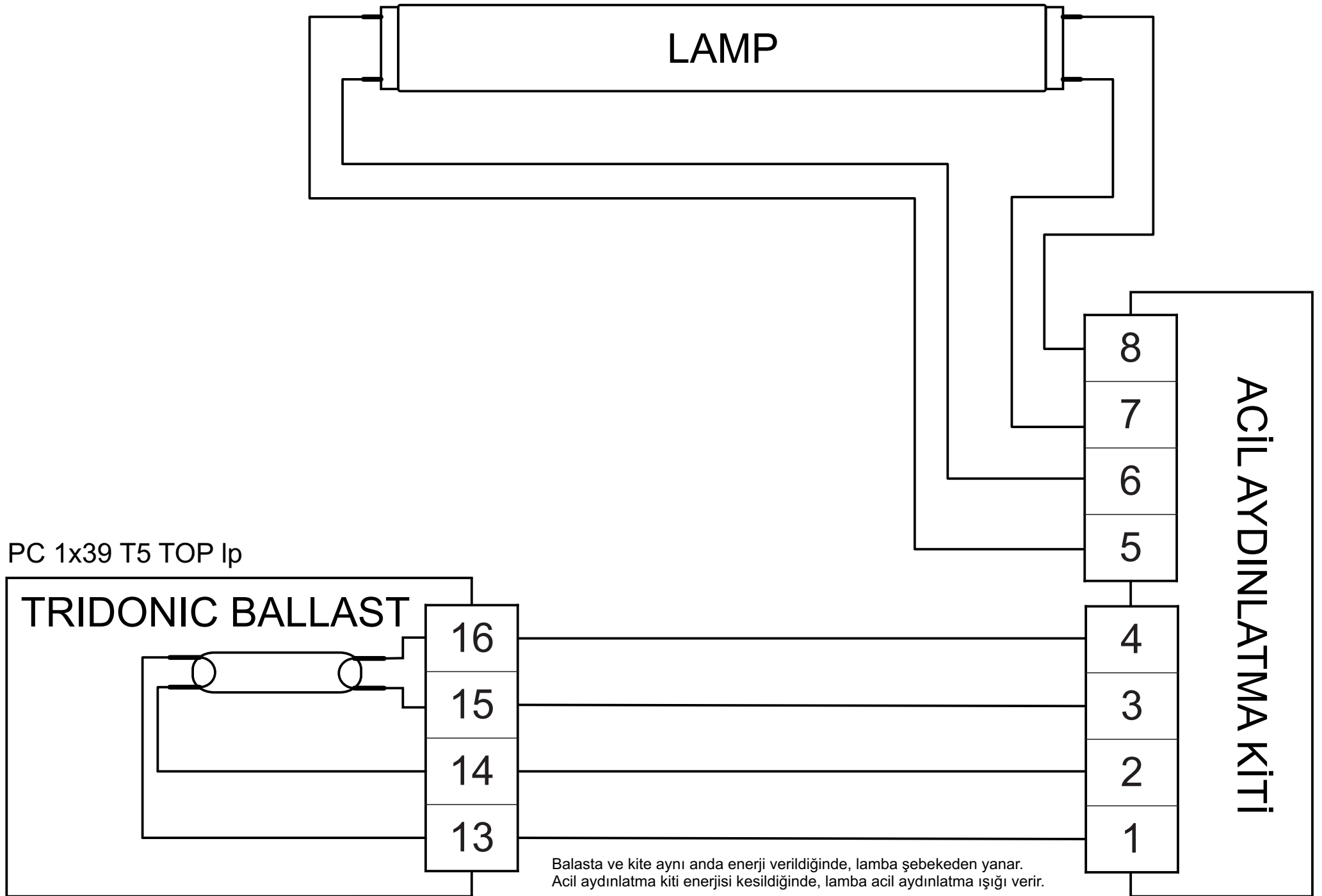

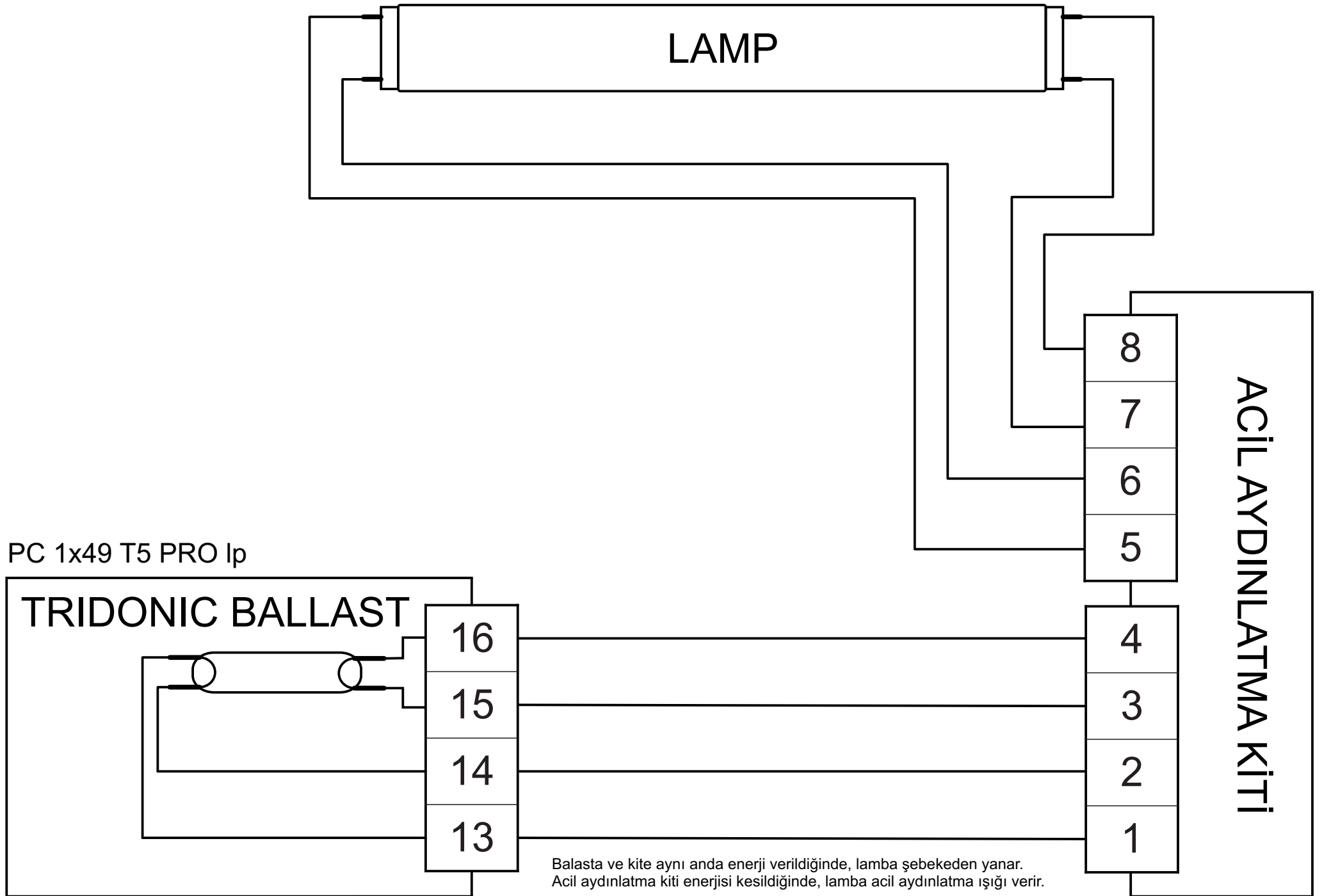

PC 1x49 T5 PRO Ip

TRIDONIC BALLAST

LAMP

ACİL AYDINLATMA KİTİ

Balasta ve kite aynı anda enerji verildiğinde, lamba şebekeden yanar.  
Acil aydınlatma kiti enerjisi kesildiğinde, lamba acil aydınlatma ışığı verir.

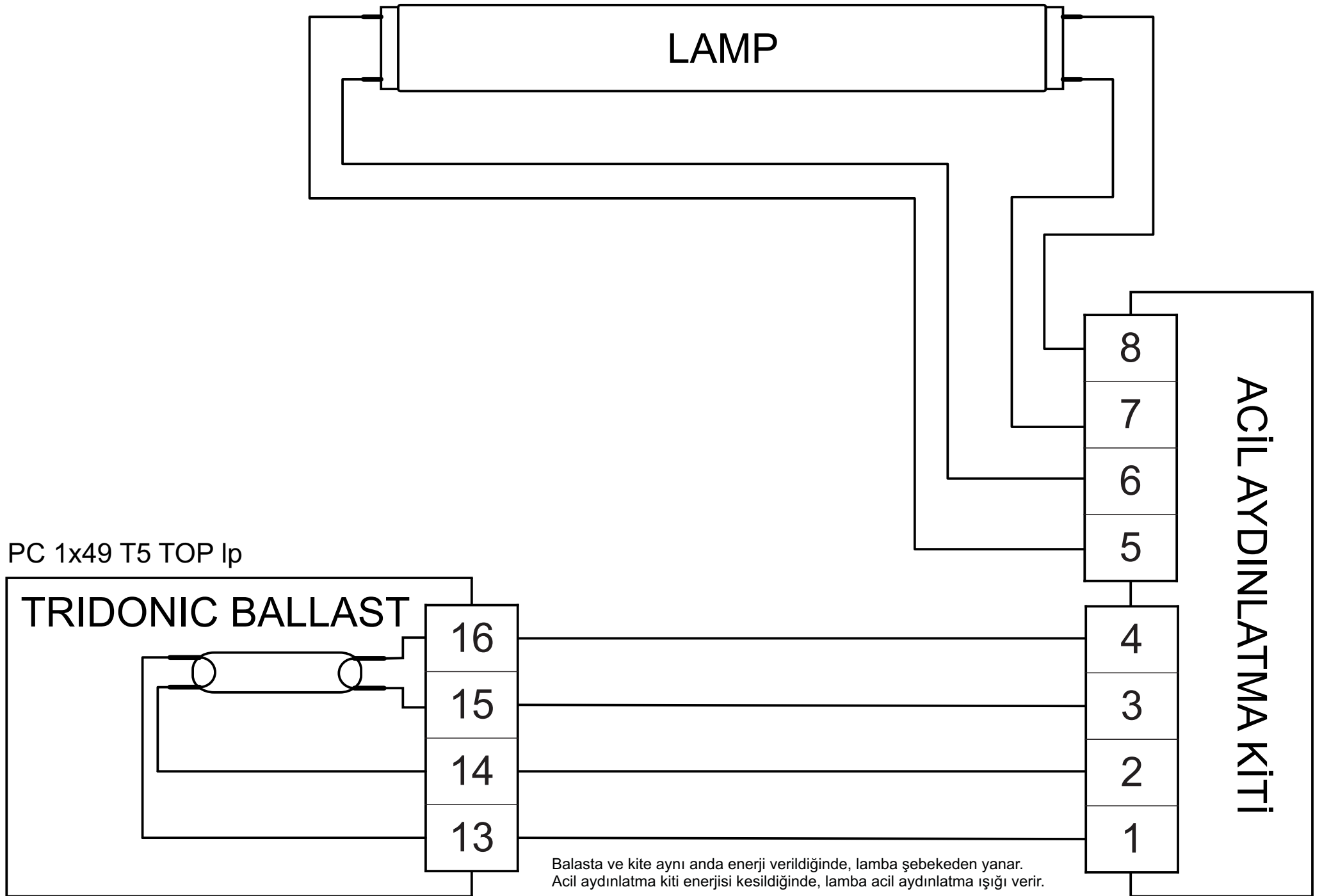

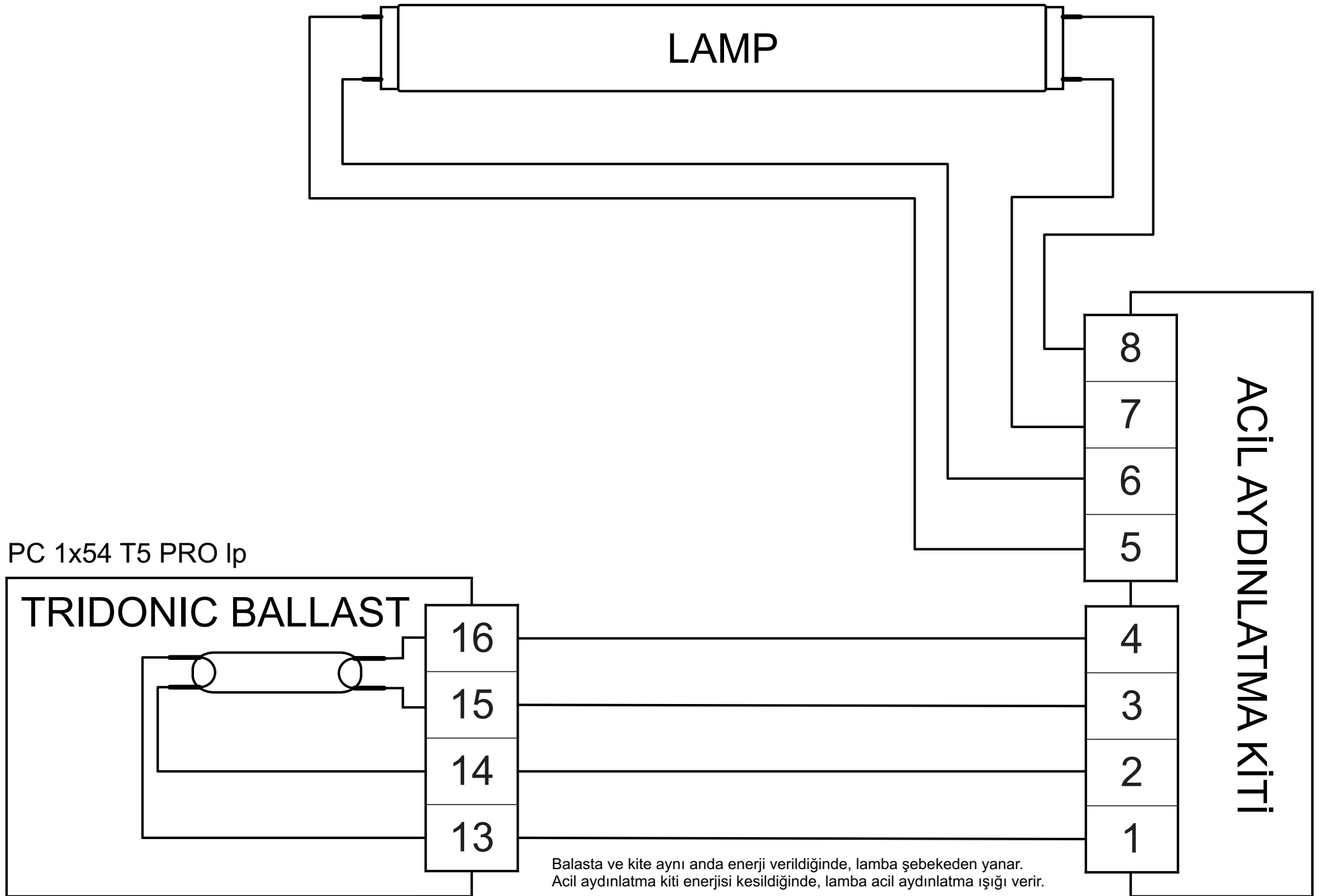

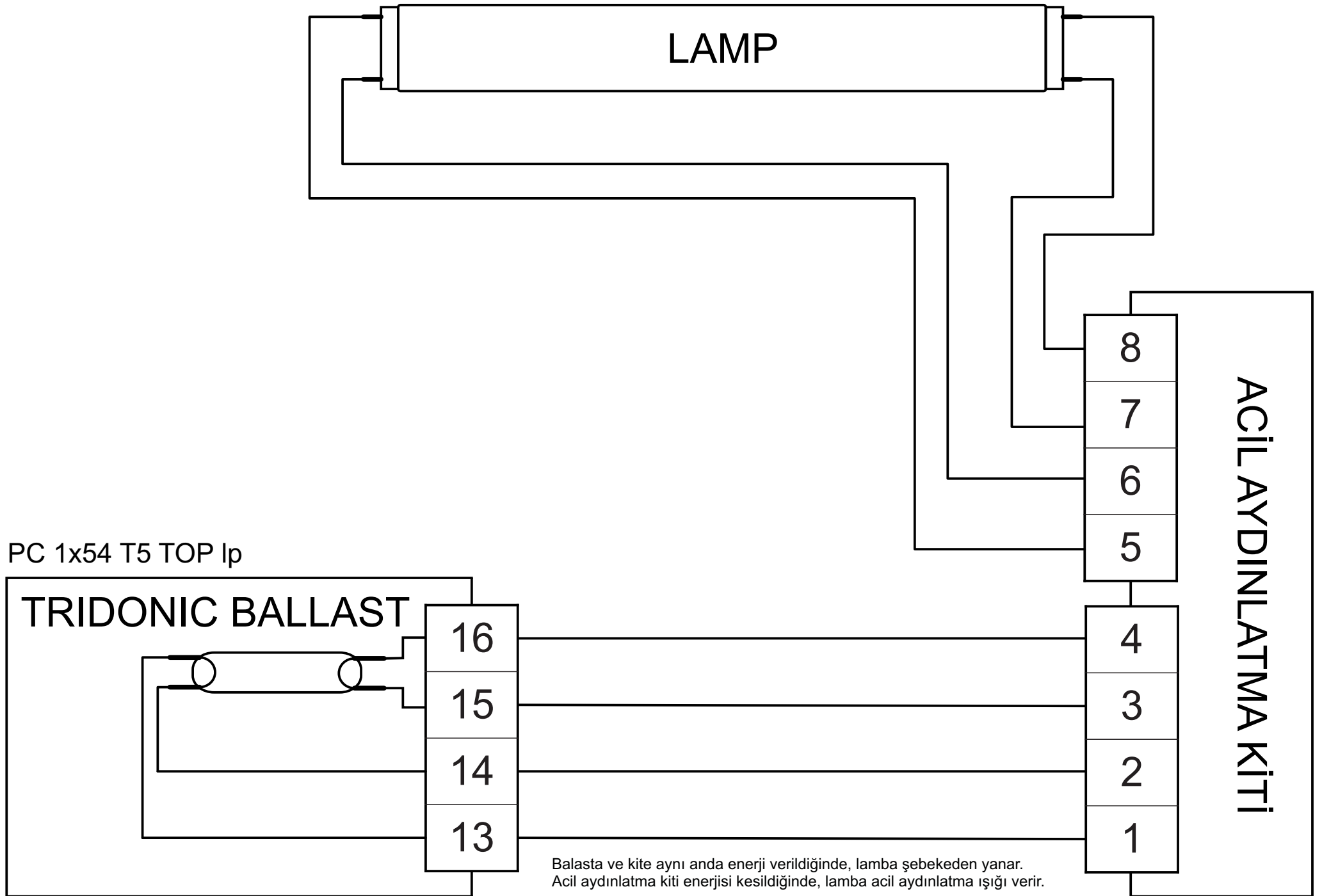



PC 1x57/70 TC PRO with 1 lamp

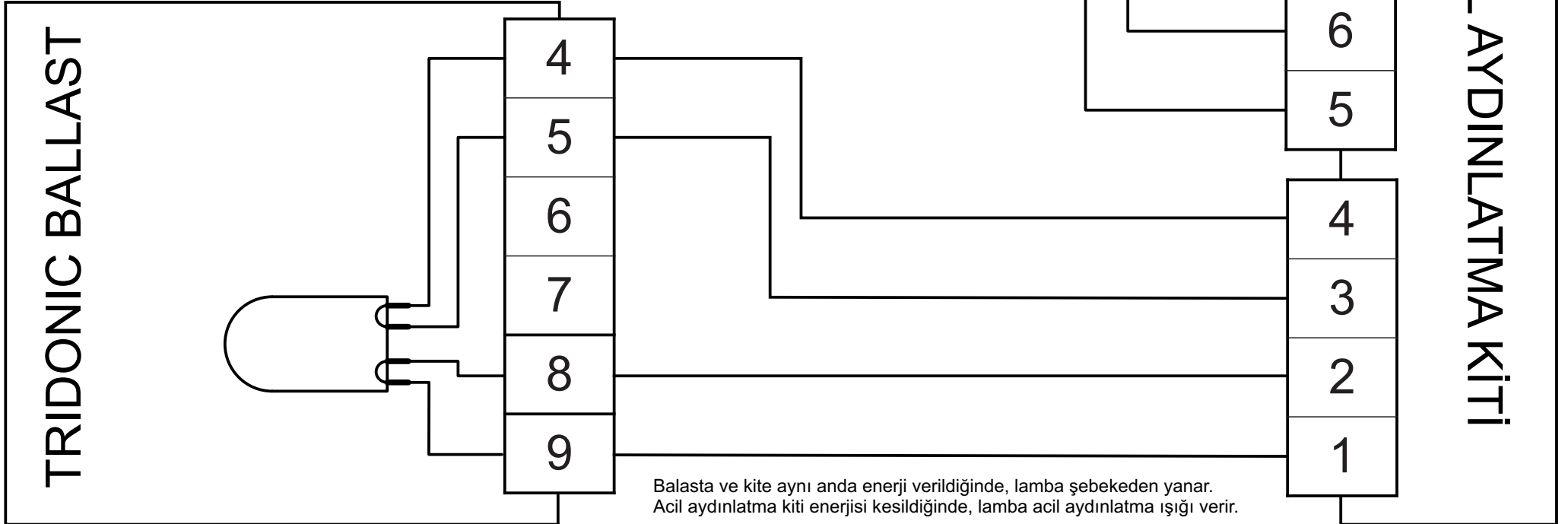

Balasta ve kite aynı anda enerji verildiğinde, lamba şebekeden yanar.  
Acil aydınlatma kiti enerjisi kesildiğinde, lamba acil aydınlatma ışığı verir.

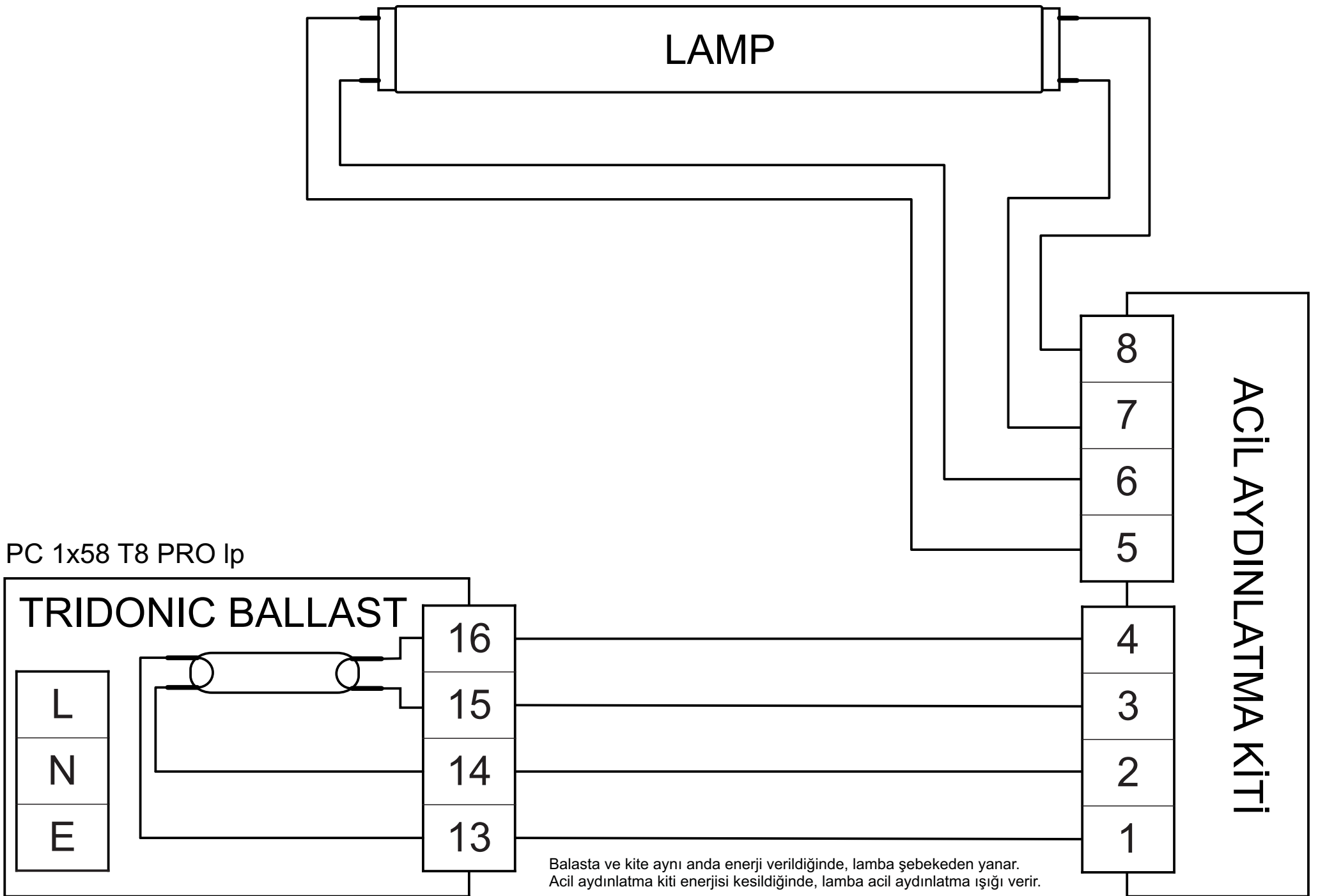

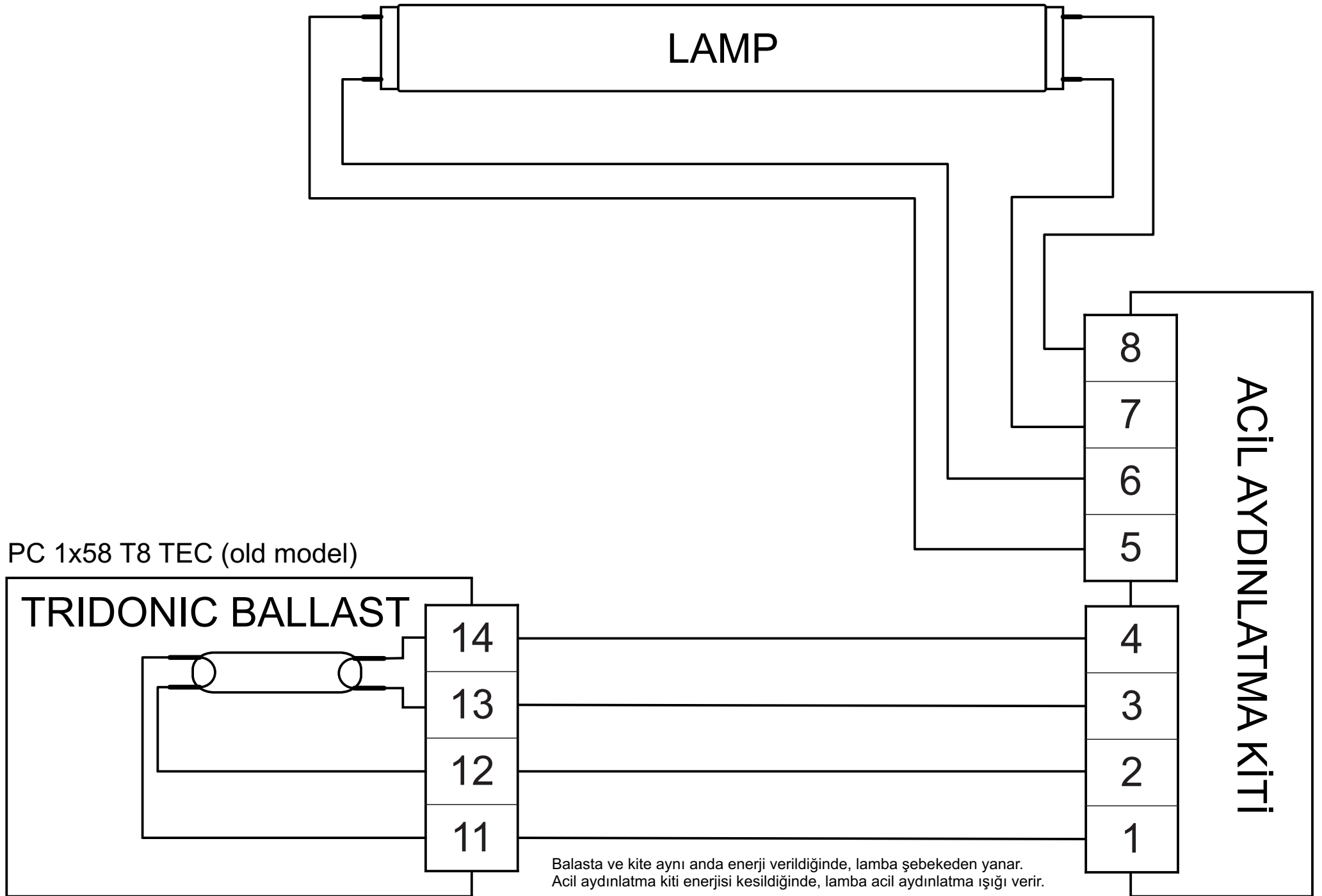

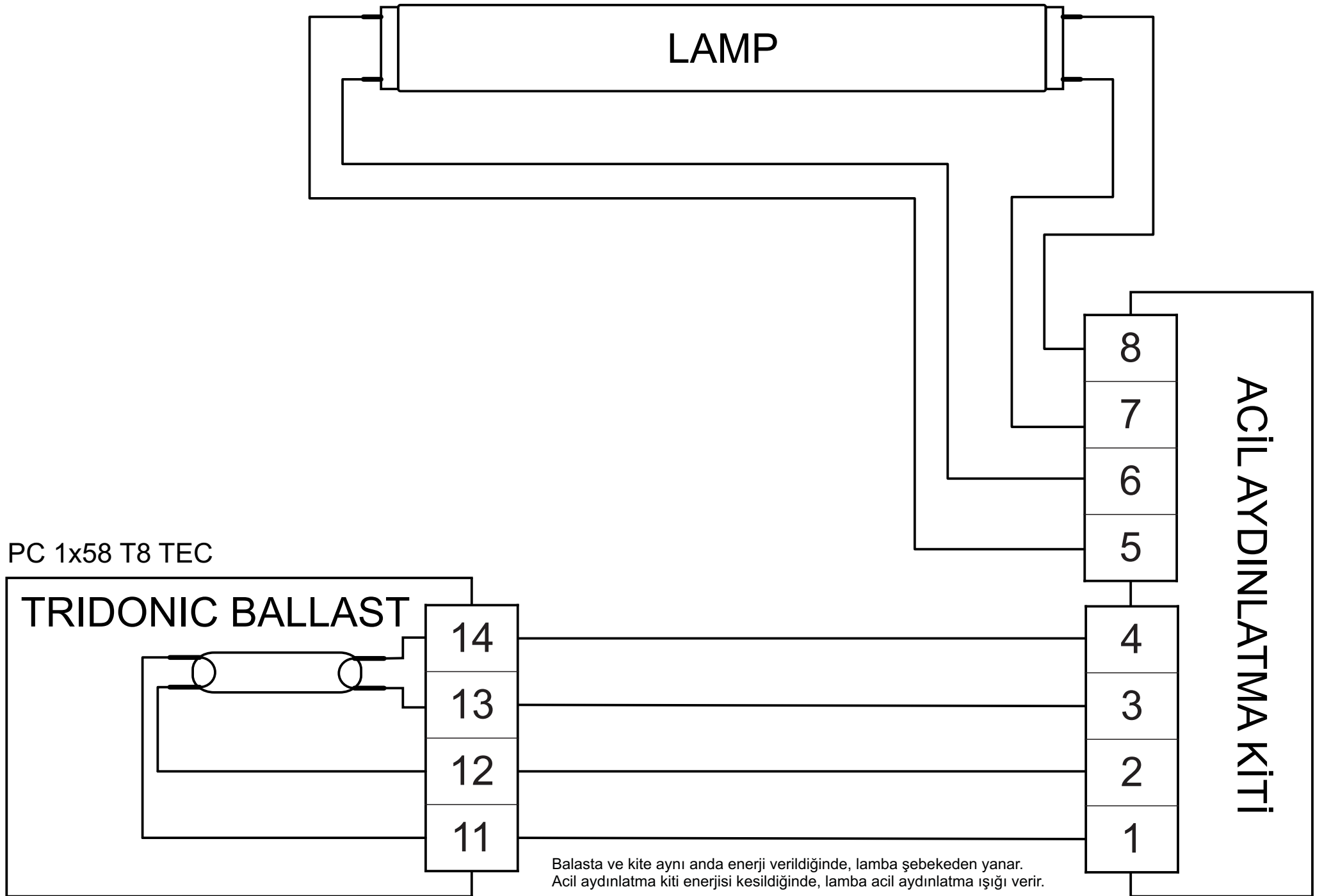

LAMP

ACIL AYDINLATMA KİTİ

PC 1x58 T8 TOP sl

TRIDONIC BALLAST

L

N

E

16

15

14

13

8

7

6

5

4

3

2

1

Balasta ve kite aynı anda enerji verildiğinde, lamba şebekeden yanar.  
Acil aydınlatma kiti enerjisi kesildiğinde, lamba acil aydınlatma ışığı verir.

