

QTi 1x14-24 DIM

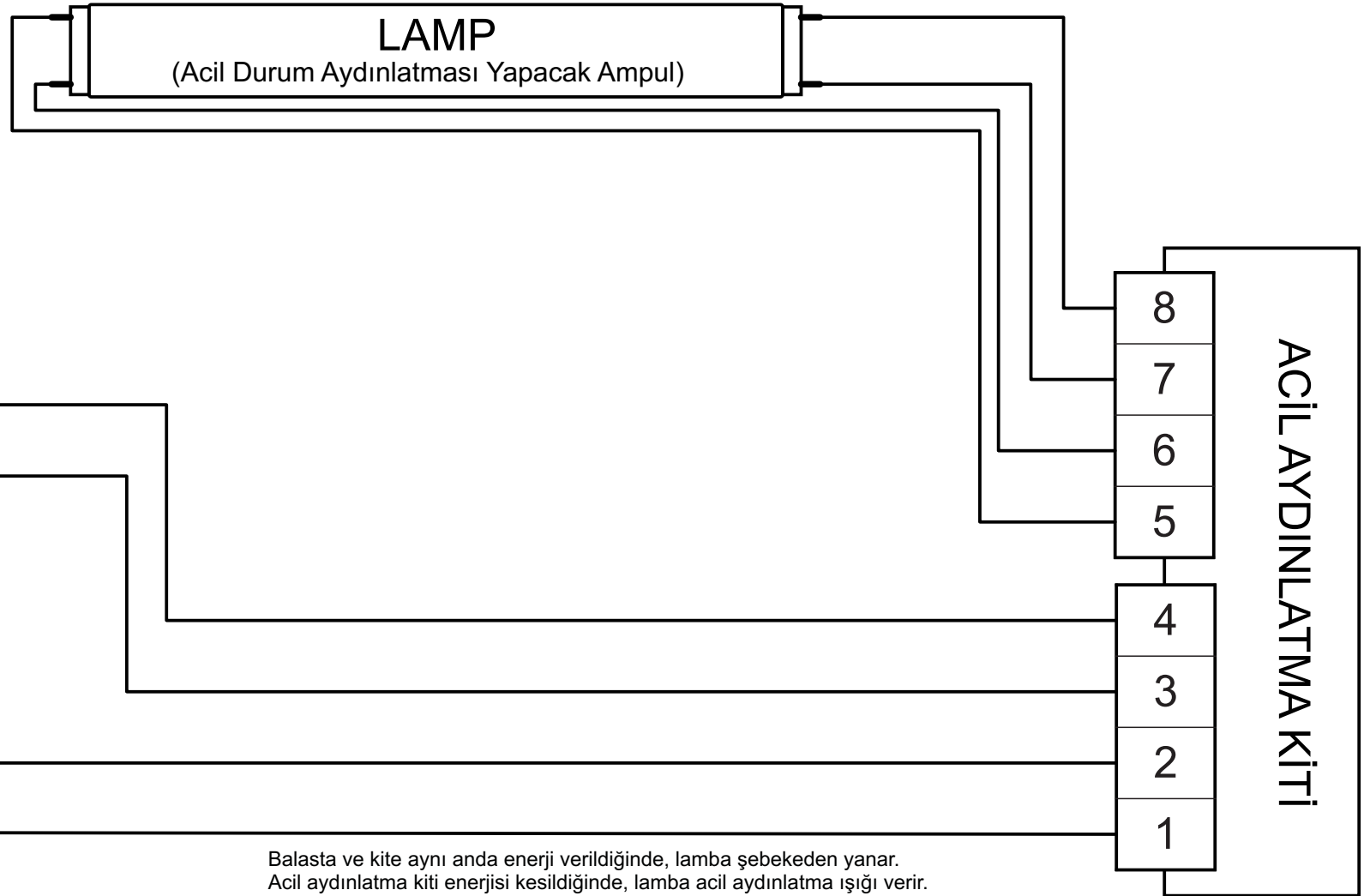

Balasta ve kite aynı anda enerji verildiğinde, lampa şebekeden yanar.  
Acil aydınlatma kiti enerjisi kesildiğinde, lampa acil aydınlatma ışığı verir.

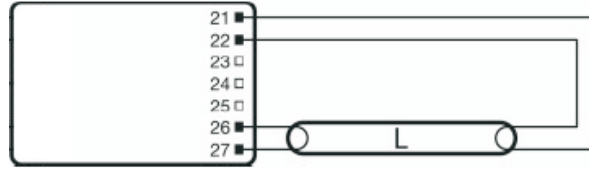
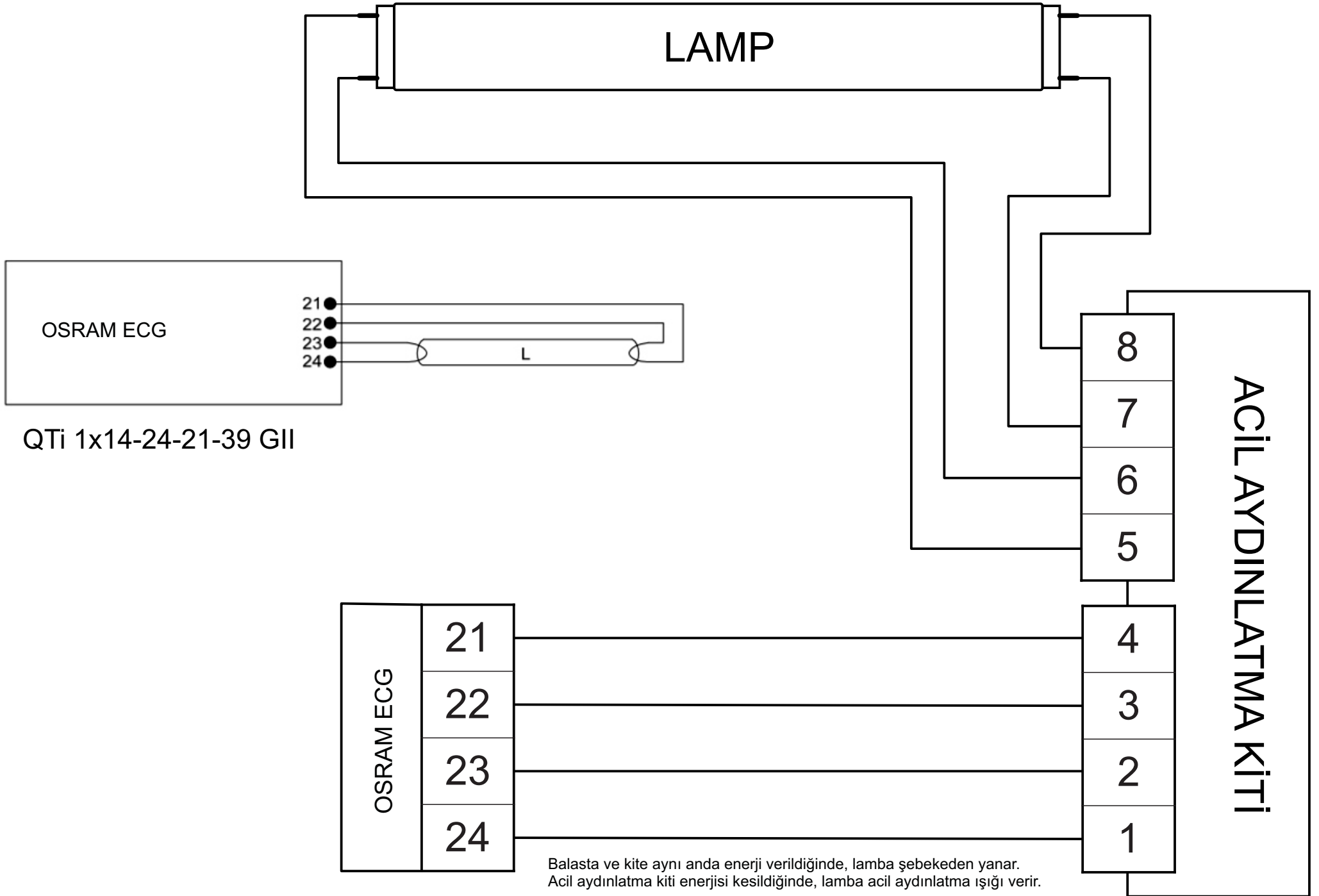

QTi 1x21-39 DIM

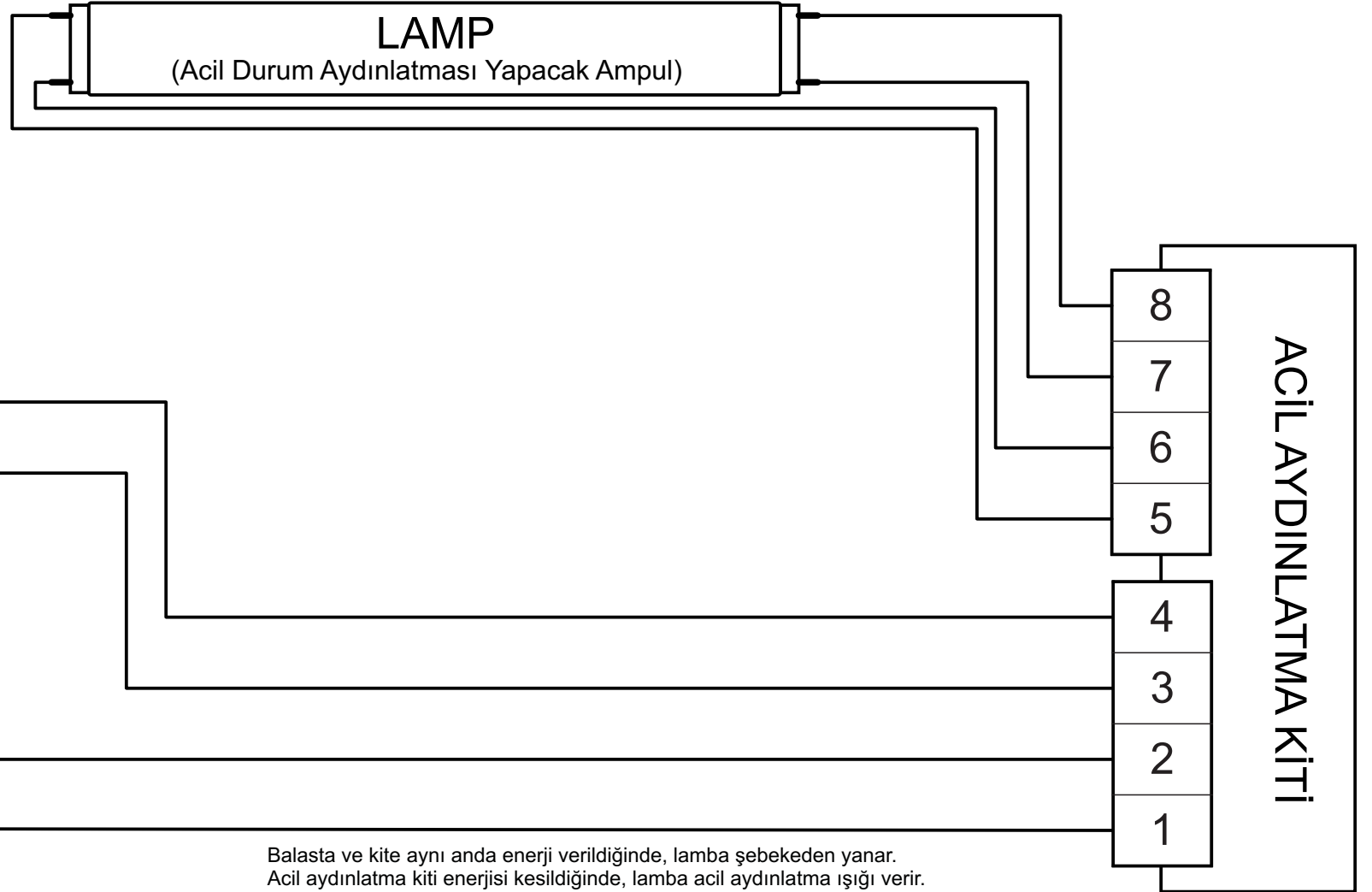
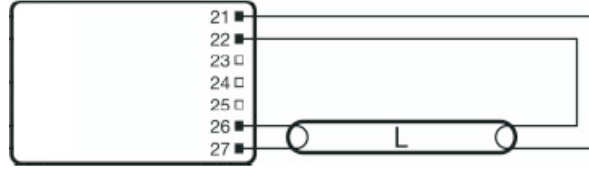

Balasta ve kite aynı anda enerji verildiğinde, lamba şebekeden yanar.  
Acil aydınlatma kiti enerjisi kesildiğinde, lamba acil aydınlatma ışığı verir.

QTi 1x28-54 DIM

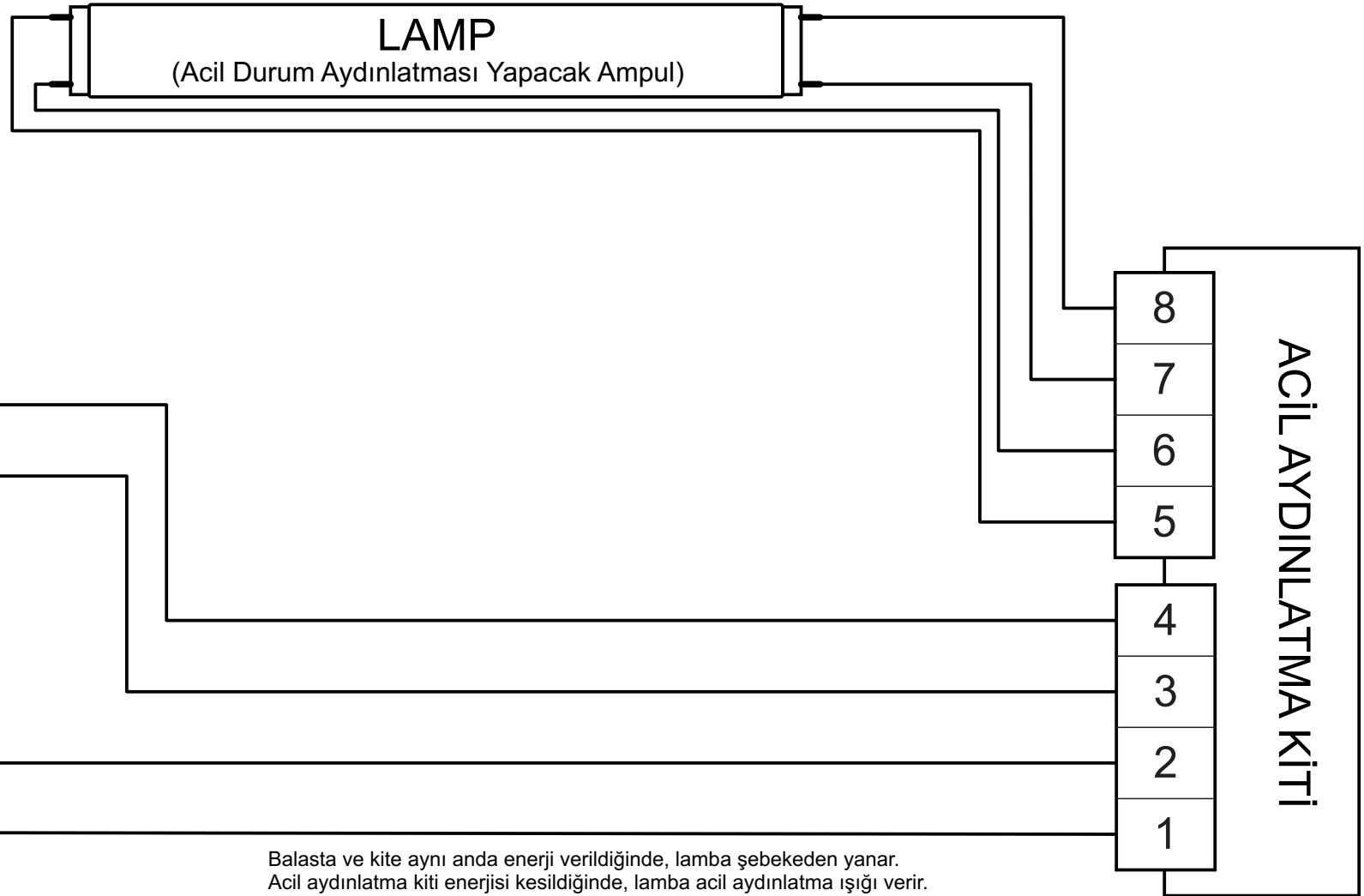
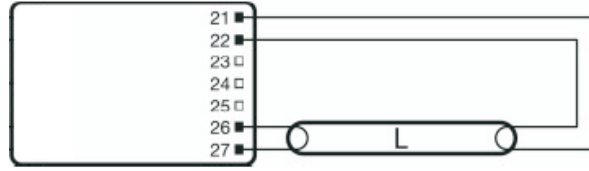

Balasta ve kite aynı anda enerji verildiğinde, lamba şebekeden yanar.  
Acil aydınlatma kiti enerjisi kesildiğinde, lamba acil aydınlatma ışığı verir.

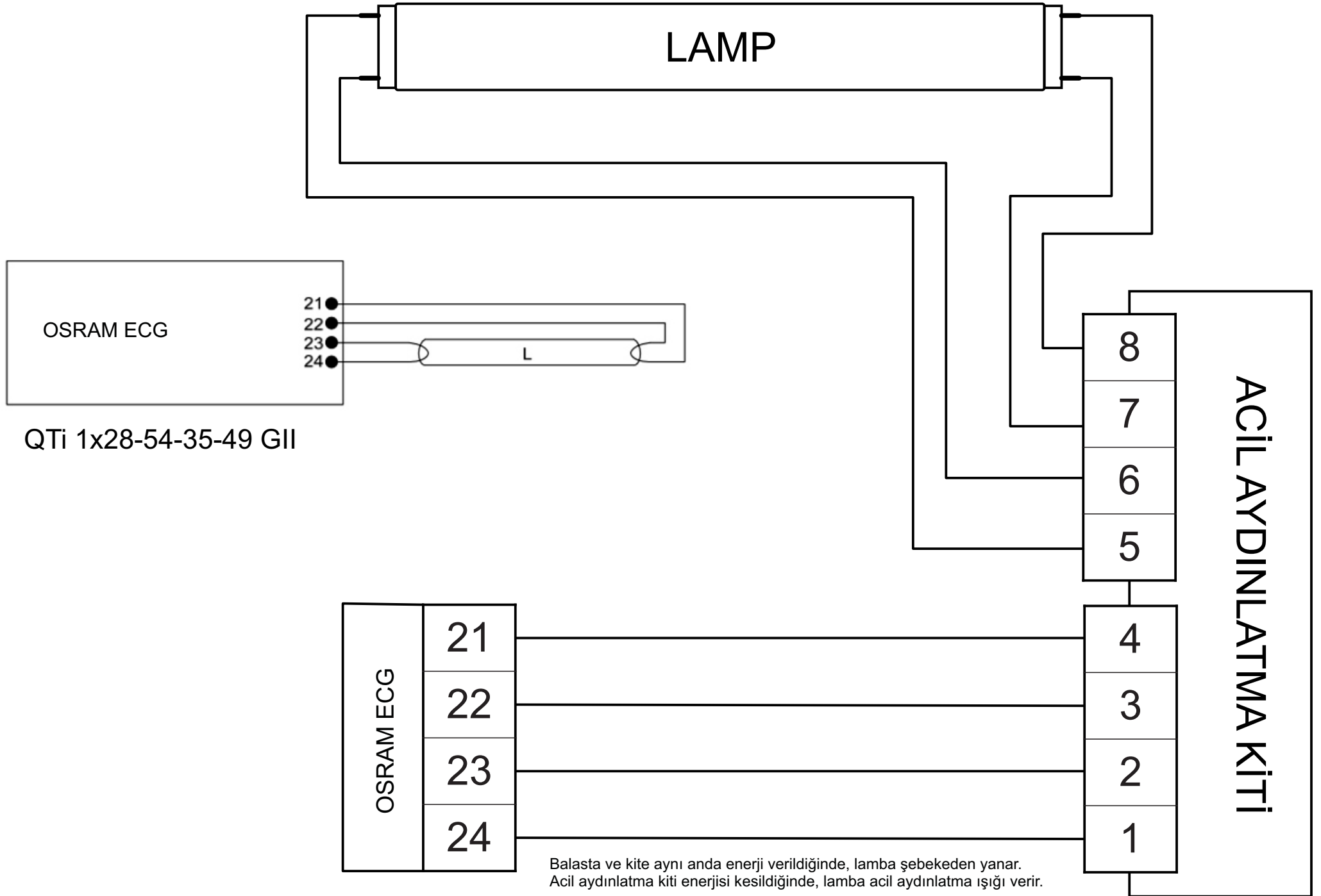

QTi 1x35-49-80 DIM

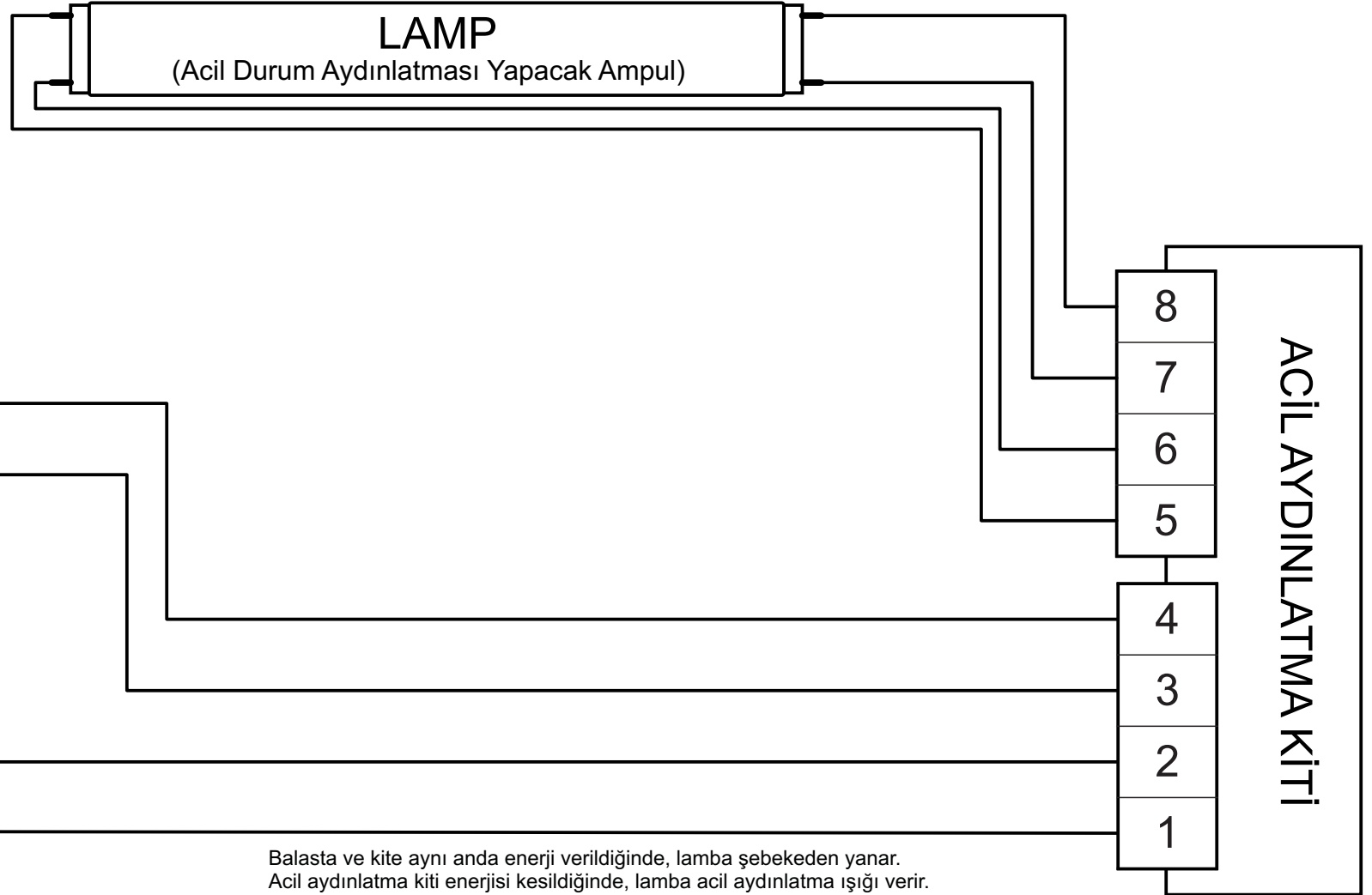
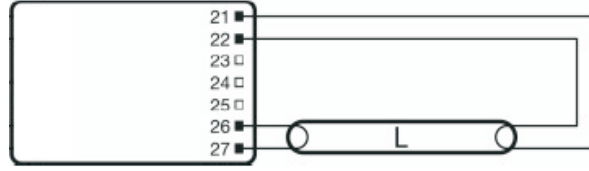

Balasta ve kite aynı anda enerji verildiğinde, lampa şebekeden yanar.  
Acil aydınlatma kiti enerjisi kesildiğinde, lampa acil aydınlatma ışığı verir.

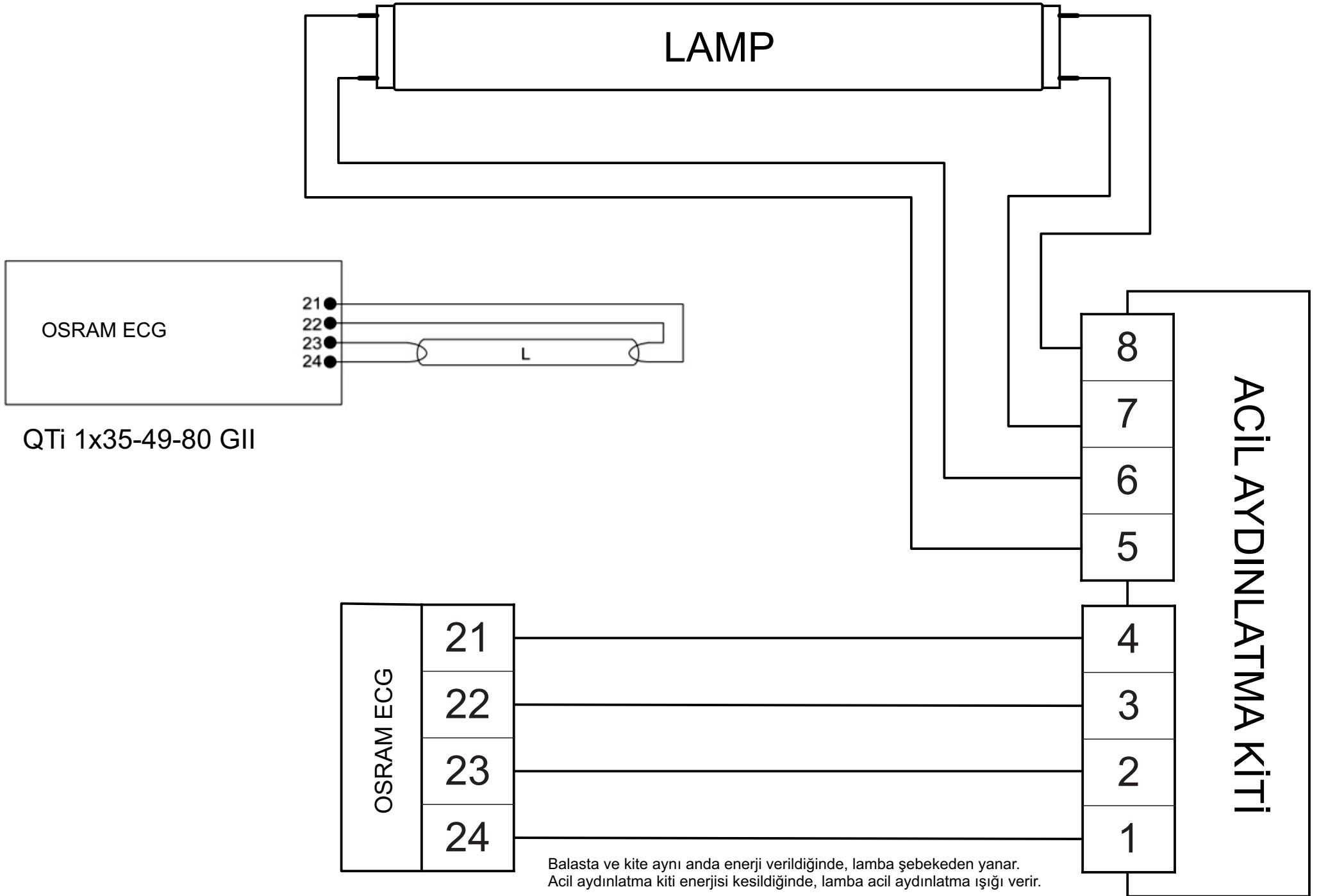

QTi 2x14-24 DIM

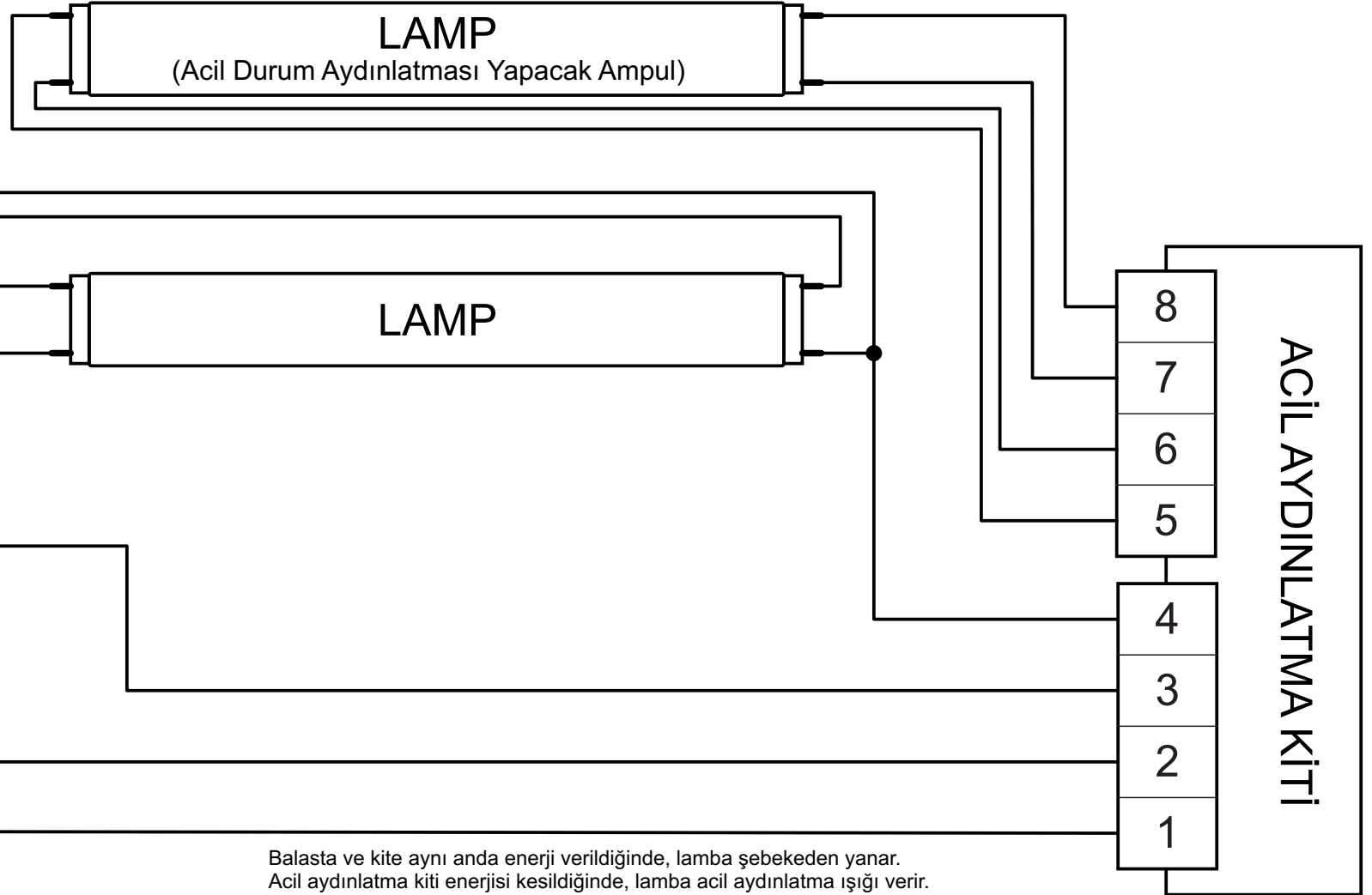
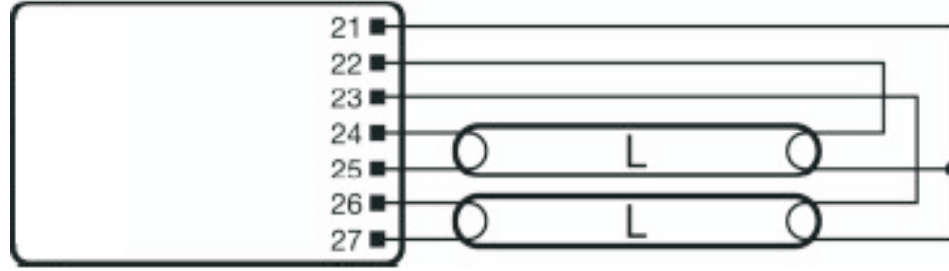

Balasta ve kite aynı anda enerji verildiğinde, lamba şebekeden yanar.  
Acil aydınlatma kiti enerjisi kesildiğinde, lamba acil aydınlatma ışığı verir.



QTi 2x14-24-21-39 GII

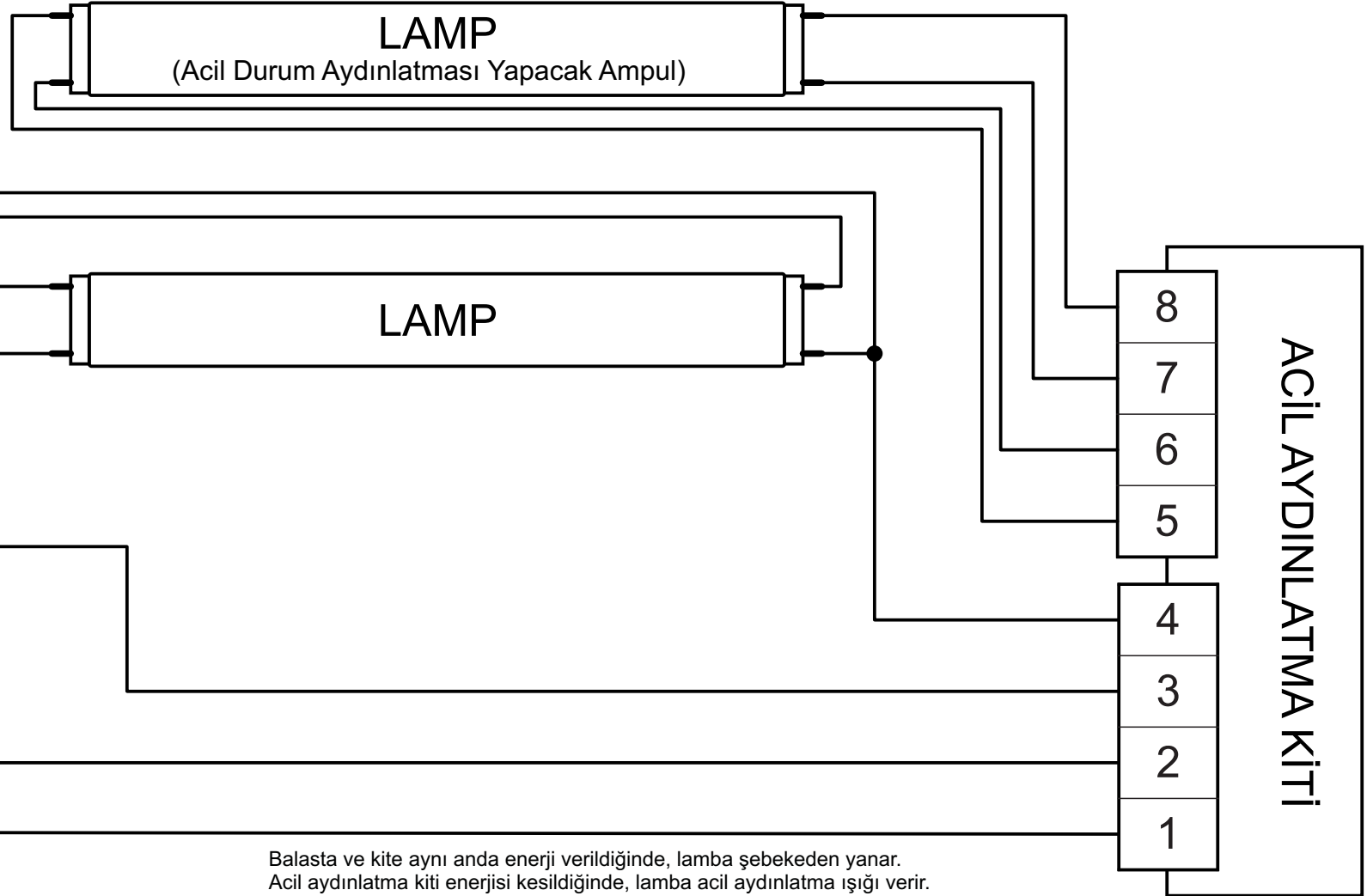
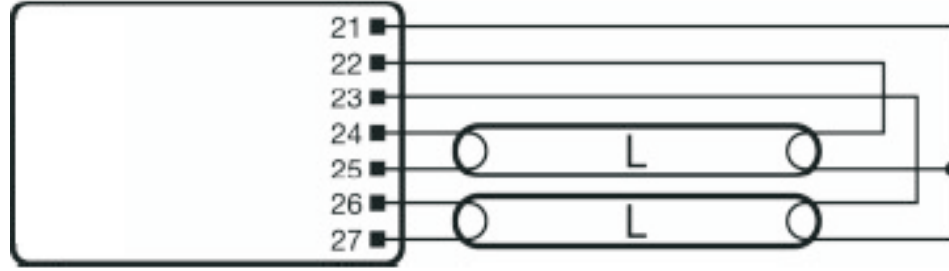

Balasta ve kite aynı anda enerji verildiğinde, lamba şebekeden yanar.  
Acil aydınlatma kiti enerjisi kesildiğinde, lamba acil aydınlatma ışığı verir.

QTi 2x21-39 DIM

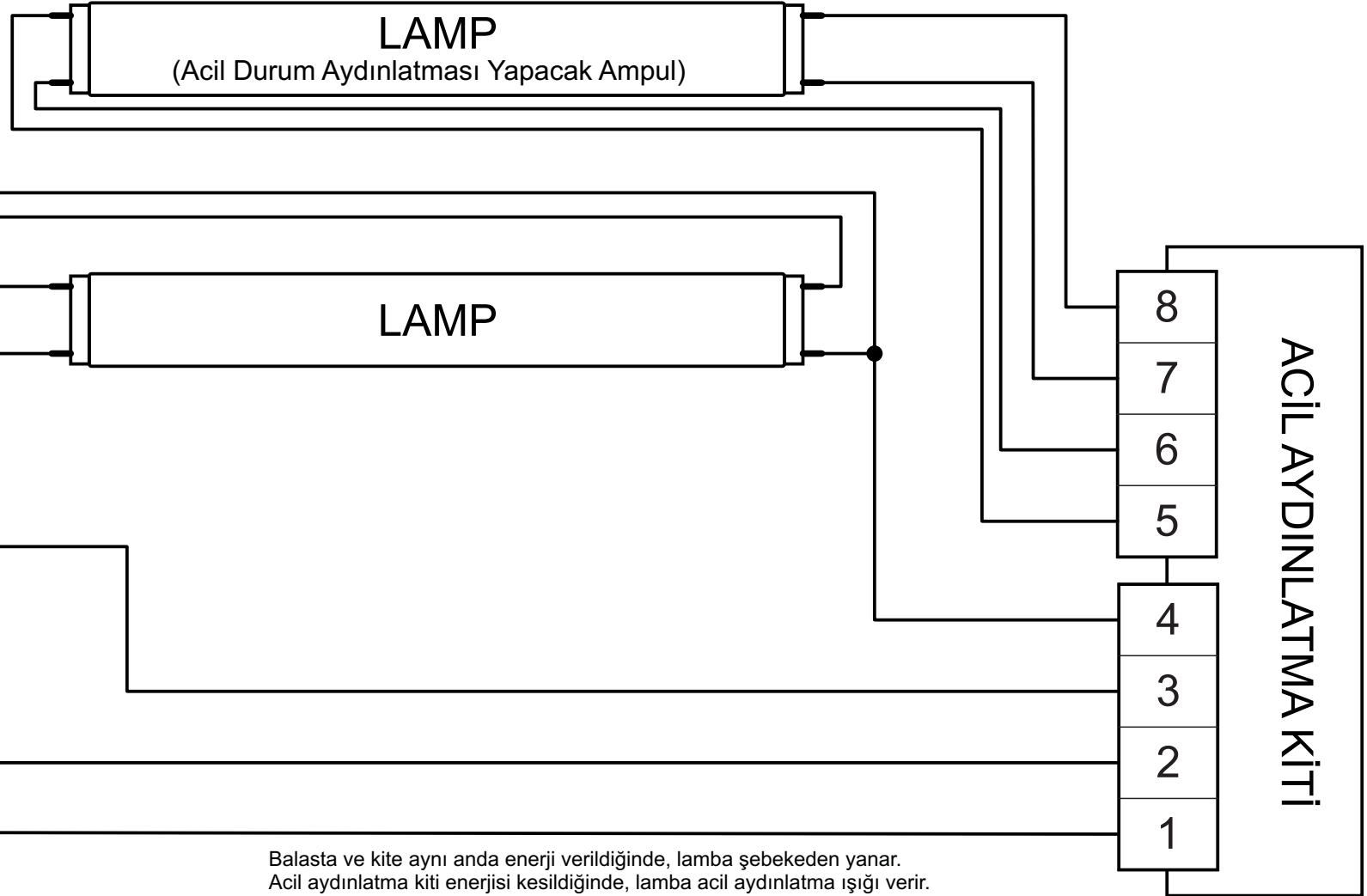
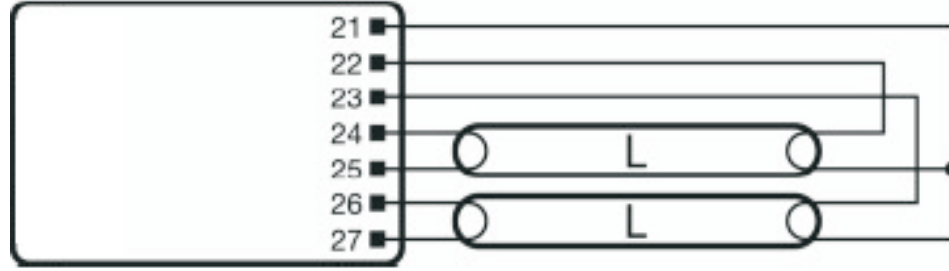

Balasta ve kite aynı anda enerji verildiğinde, lamba şebekeden yanar.  
Acil aydınlatma kiti enerjisi kesildiğinde, lamba acil aydınlatma ışığı verir.

QTi 2x28-54 DIM

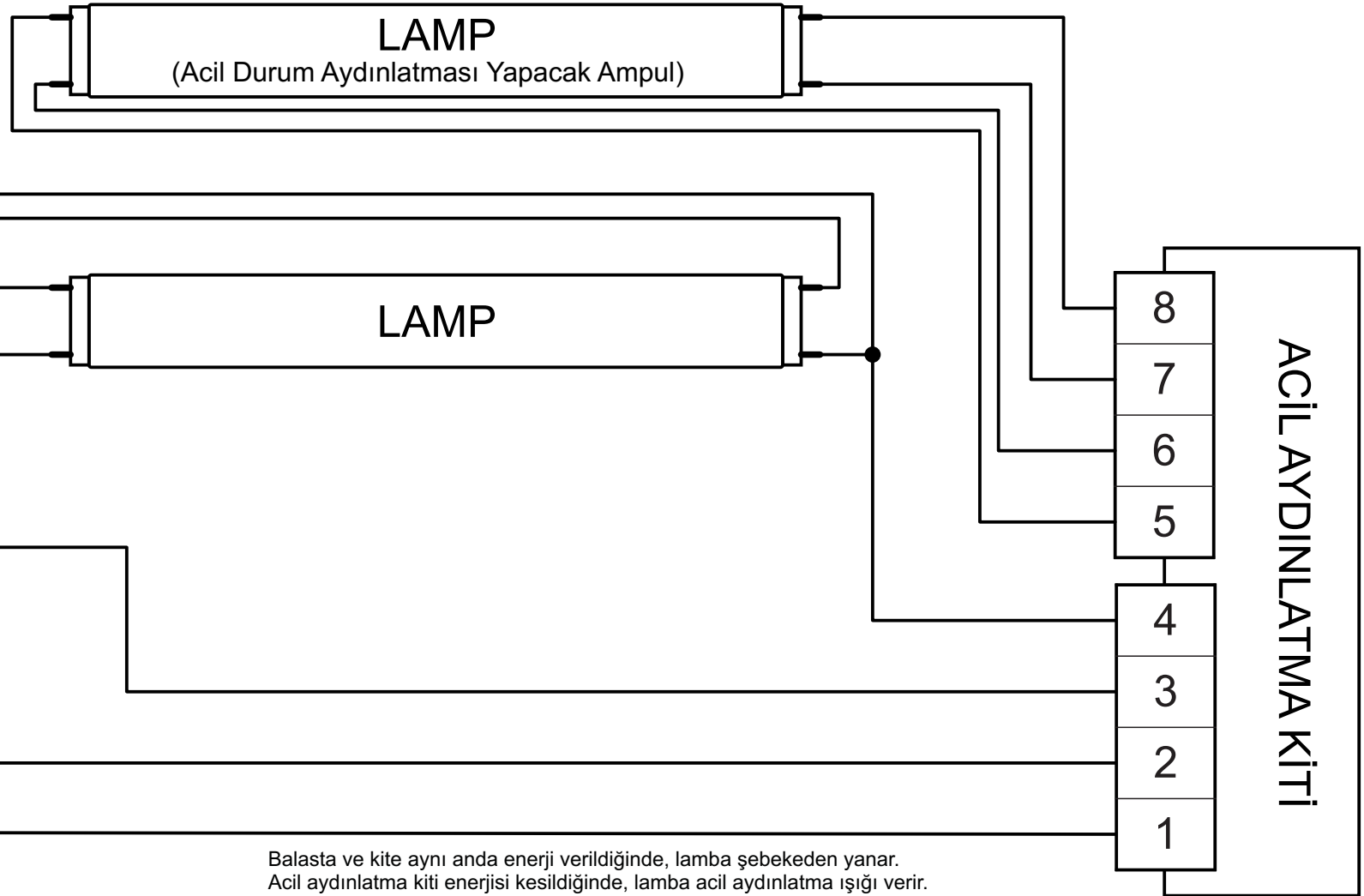
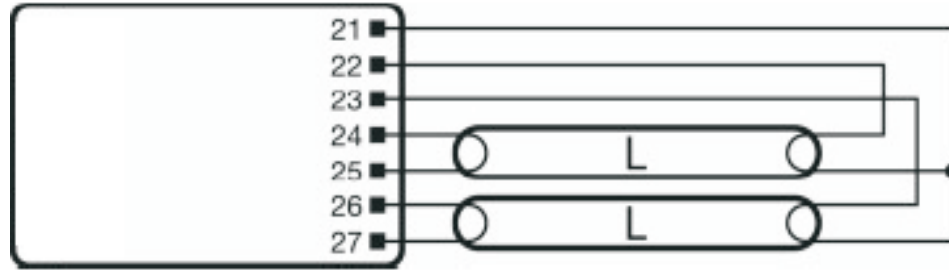

Balasta ve kite aynı anda enerji verildiğinde, lamba şebekeden yanar.  
Acil aydınlatma kiti enerjisi kesildiğinde, lamba acil aydınlatma ışığı verir.

QTi 2x28-54-35-49 GII

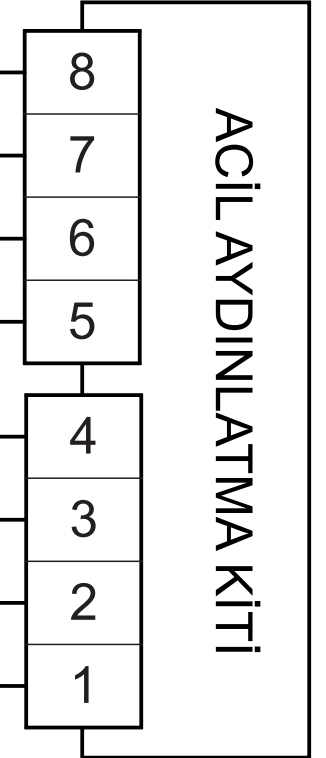
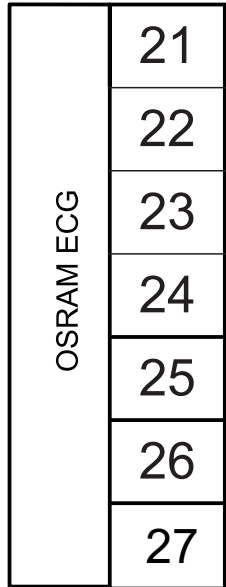
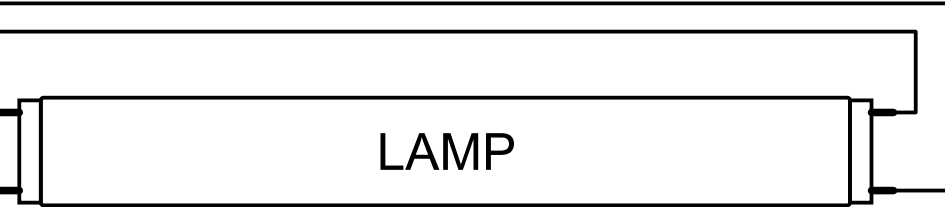
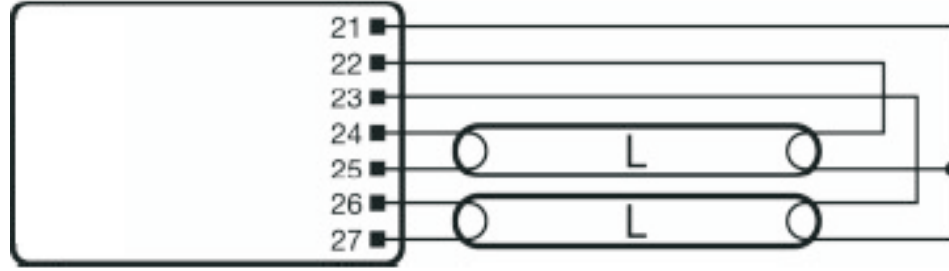

Balasta ve kite aynı anda enerji verildiğinde, lamba şebekeden yanar.  
Acil aydınlatma kiti enerjisi kesildiğinde, lamba acil aydınlatma ışığı verir.

QTi 2x35-49 DIM

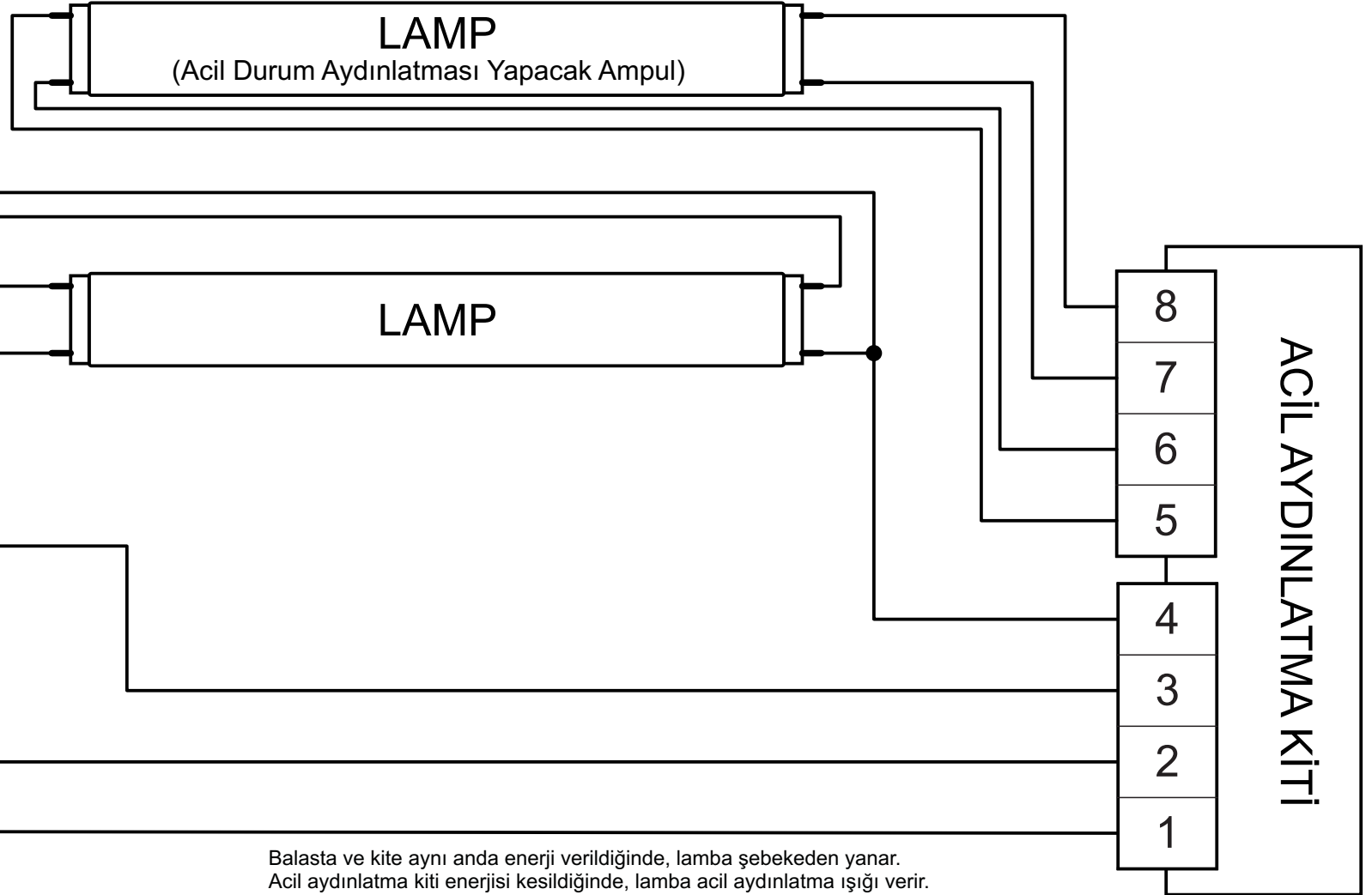
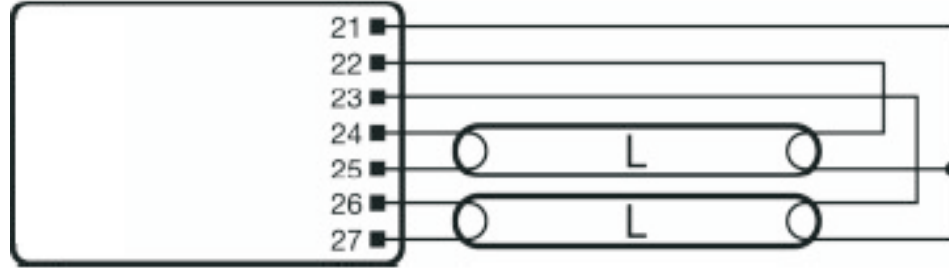

Balasta ve kite aynı anda enerji verildiğinde, lamba şebekeden yanar.  
Acil aydınlatma kiti enerjisi kesildiğinde, lamba acil aydınlatma ışığı verir.

QTi 2x35-49-80 DIM

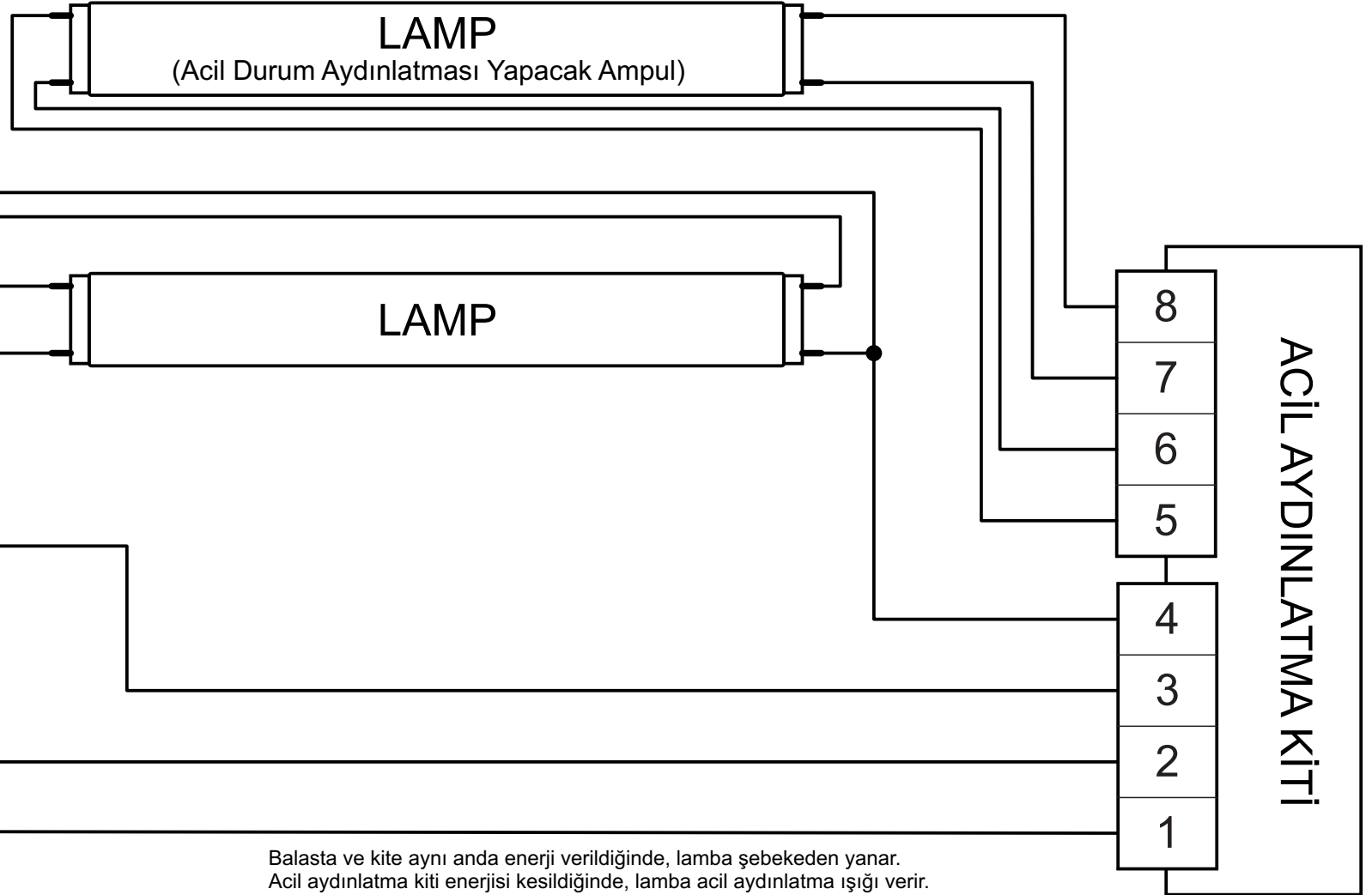
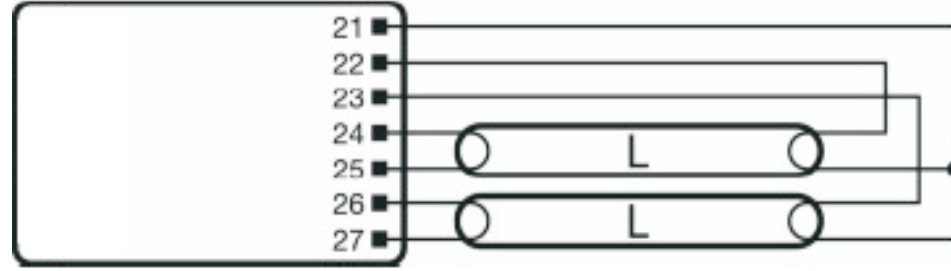

Balasta ve kite aynı anda enerji verildiğinde, lampa şebekeden yanar.  
Acil aydınlatma kiti enerjisi kesildiğinde, lampa acil aydınlatma ışığı verir.

QTi 2x35-49-80 GII

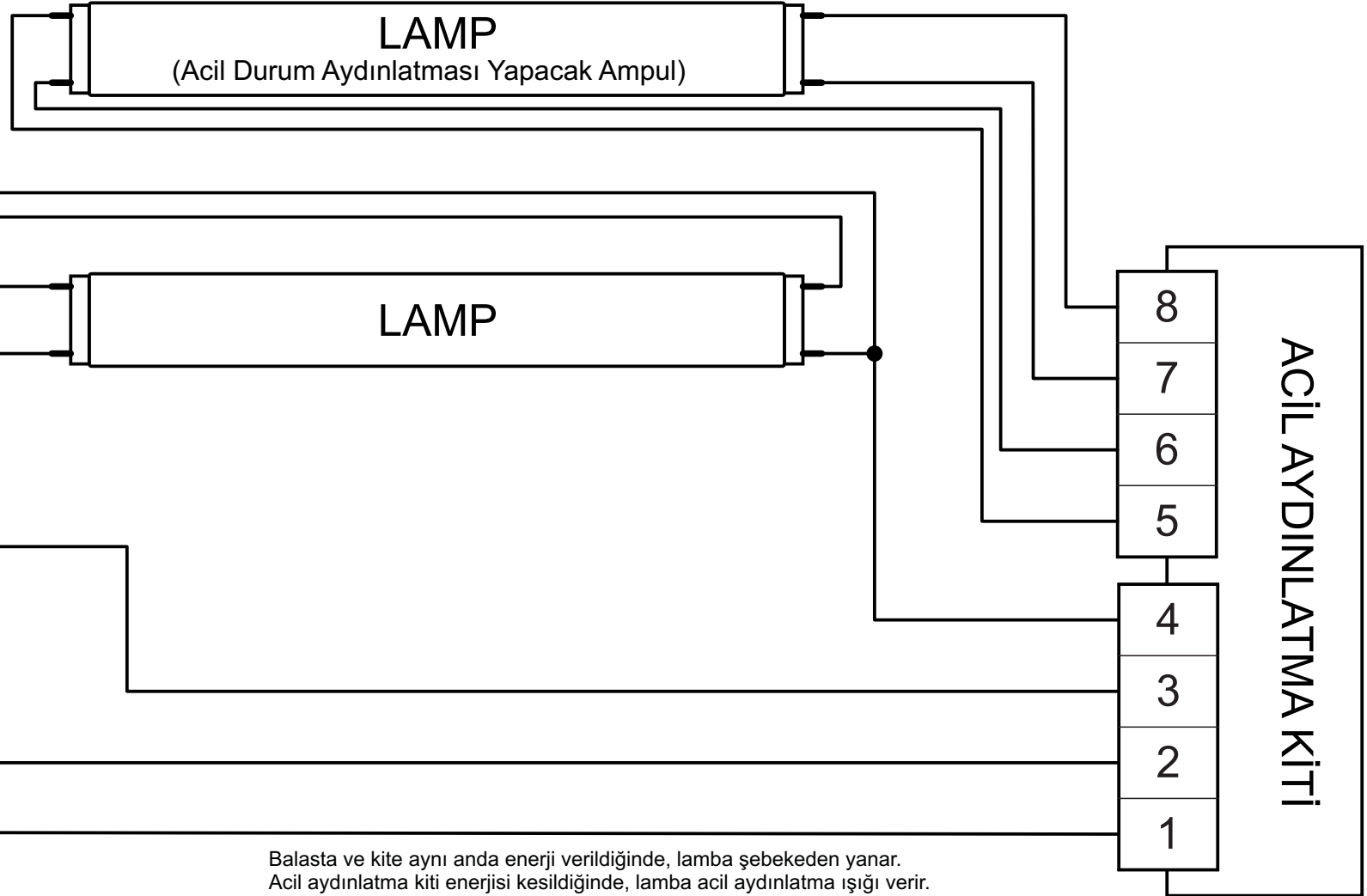
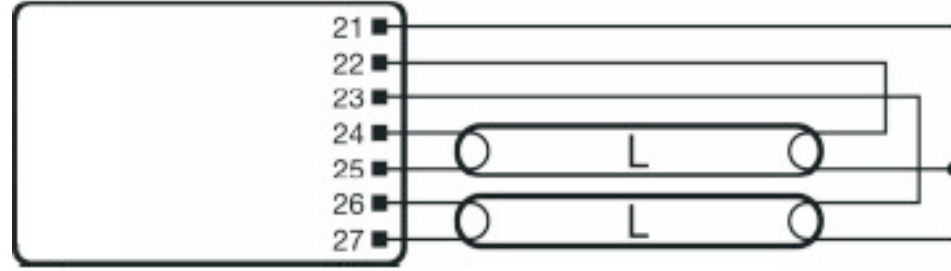

Balasta ve kite aynı anda enerji verildiğinde, lamba şebekeden yanar.  
Acil aydınlatma kiti enerjisi kesildiğinde, lamba acil aydınlatma ışığı verir.

QTi 2x35-49-80

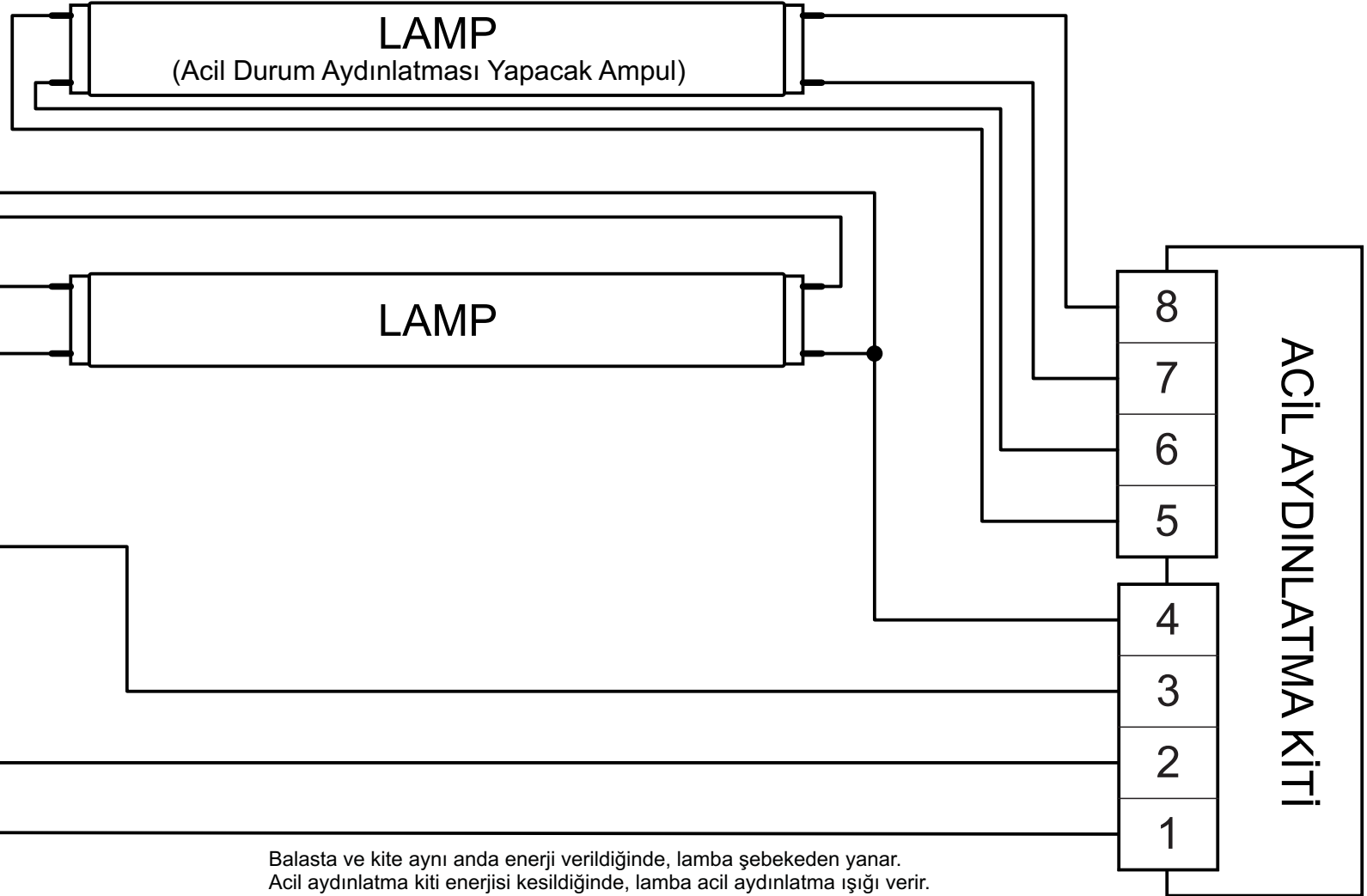
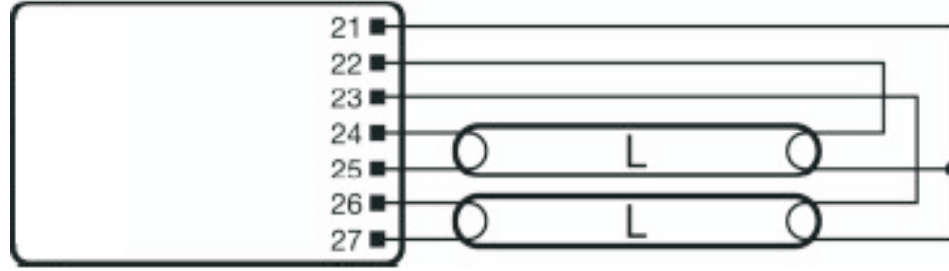

Balasta ve kite aynı anda enerji verildiğinde, lamba şebekeden yanar.  
Acil aydınlatma kiti enerjisi kesildiğinde, lamba acil aydınlatma ışığı verir.



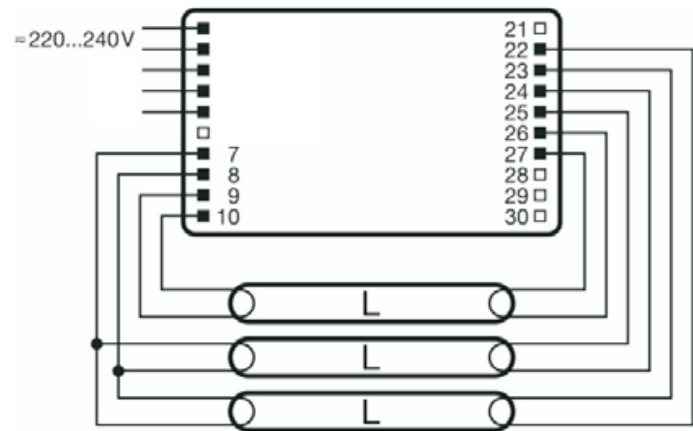

QTi 3x14 DIM

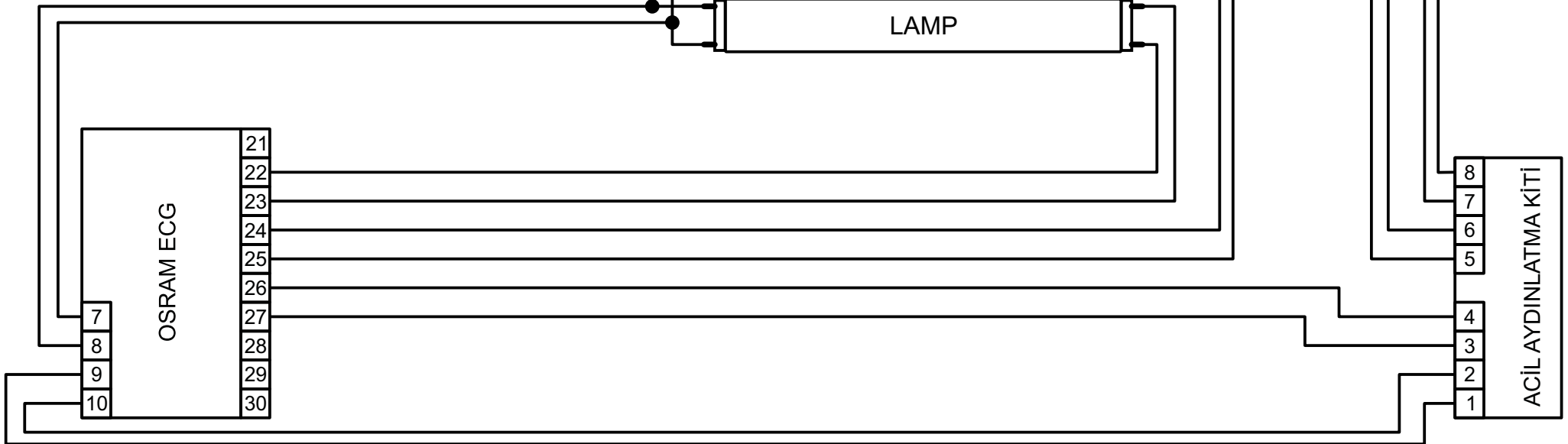
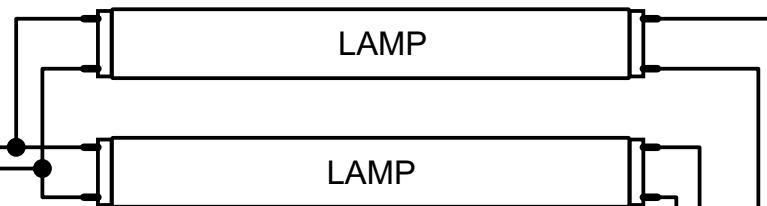
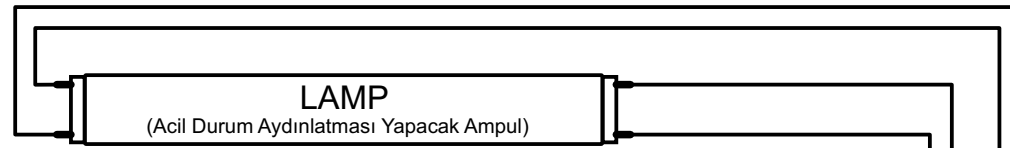

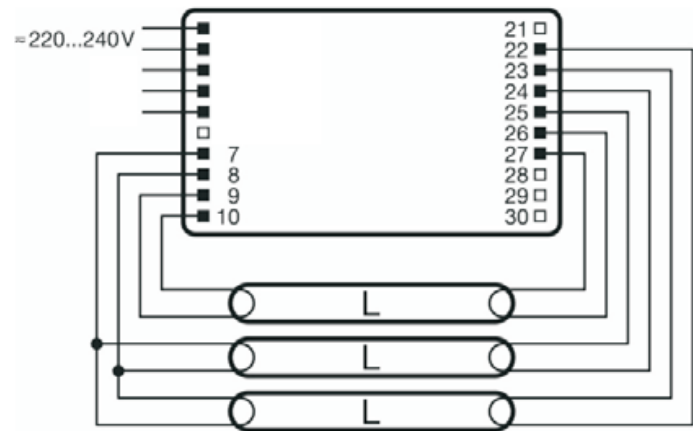

Qti 3x18 DIM

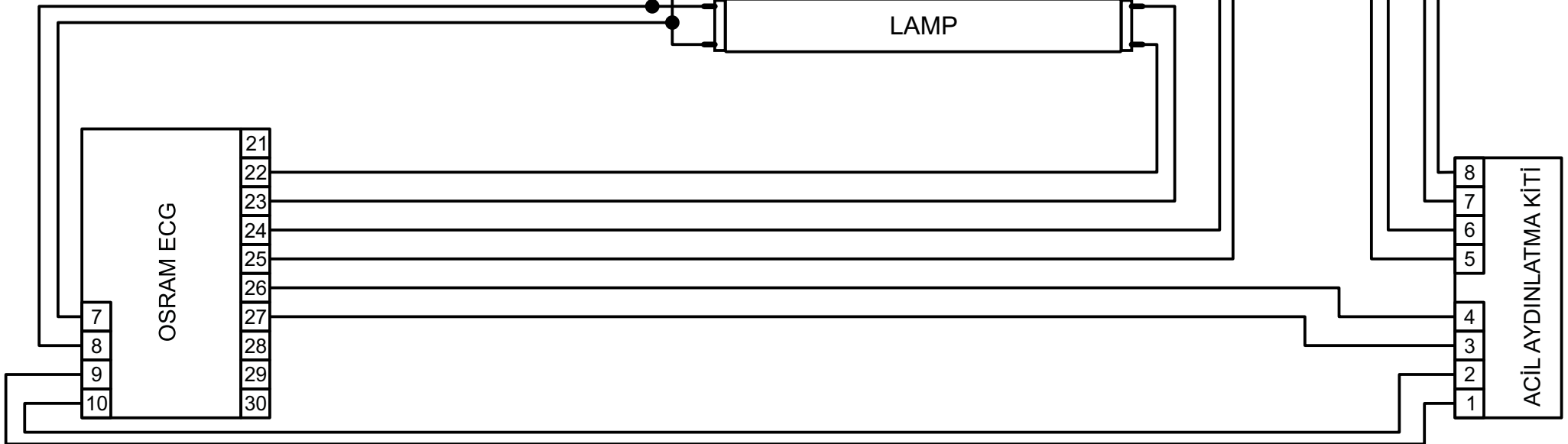
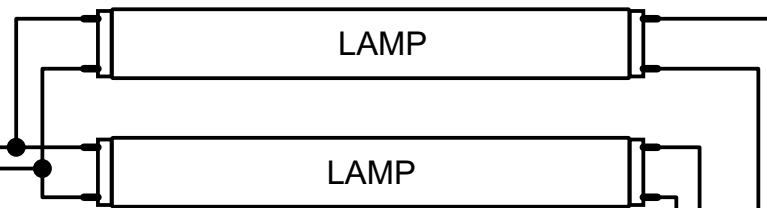
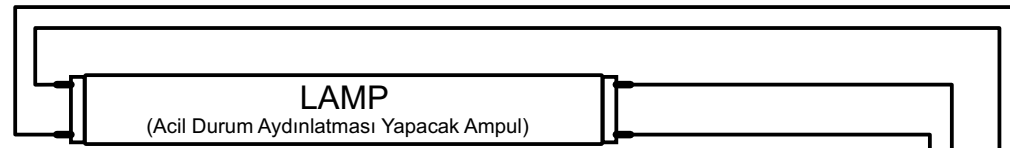

# QTi 4x14 DIM

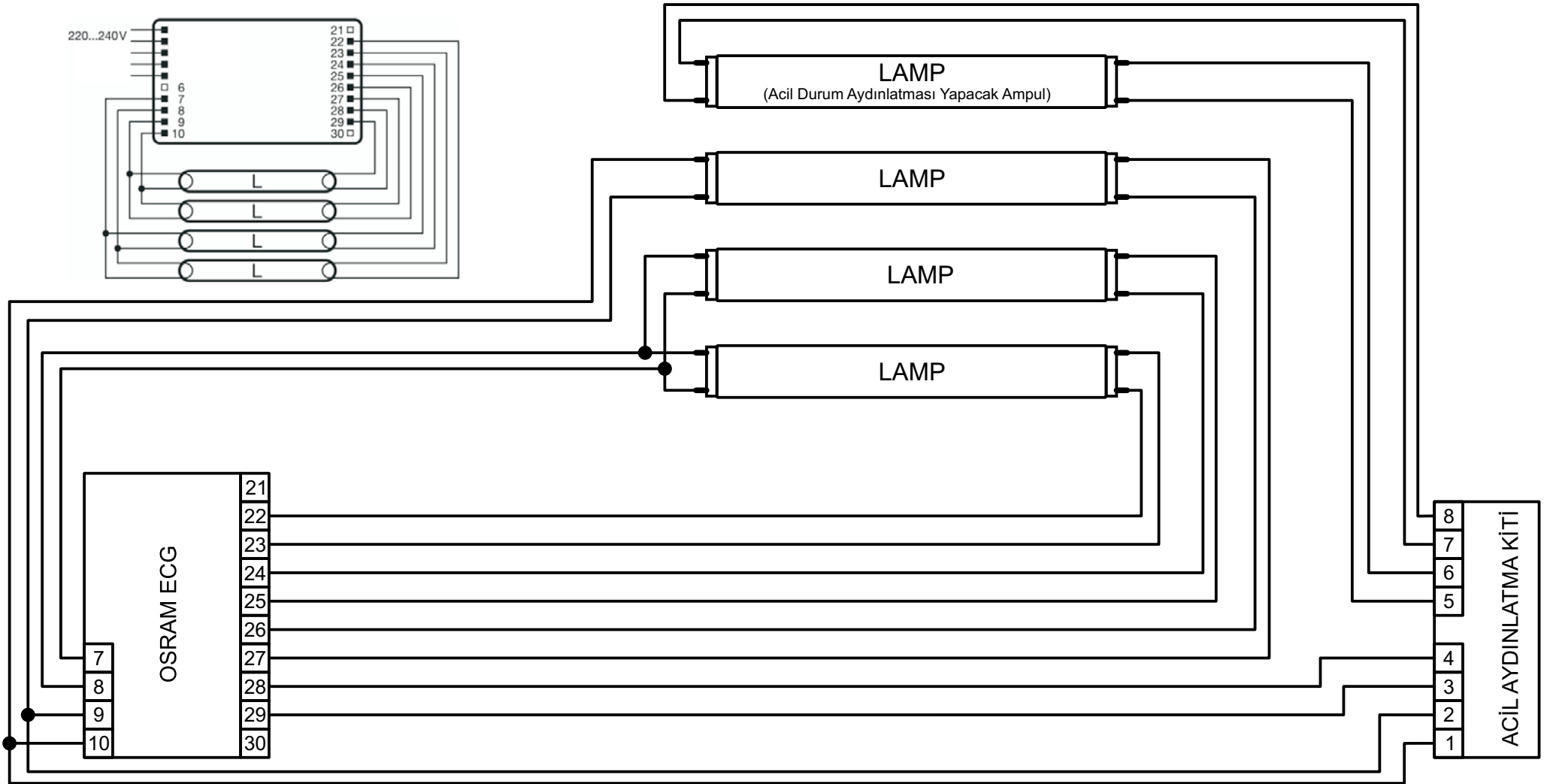

# QTi 4x18 DIM

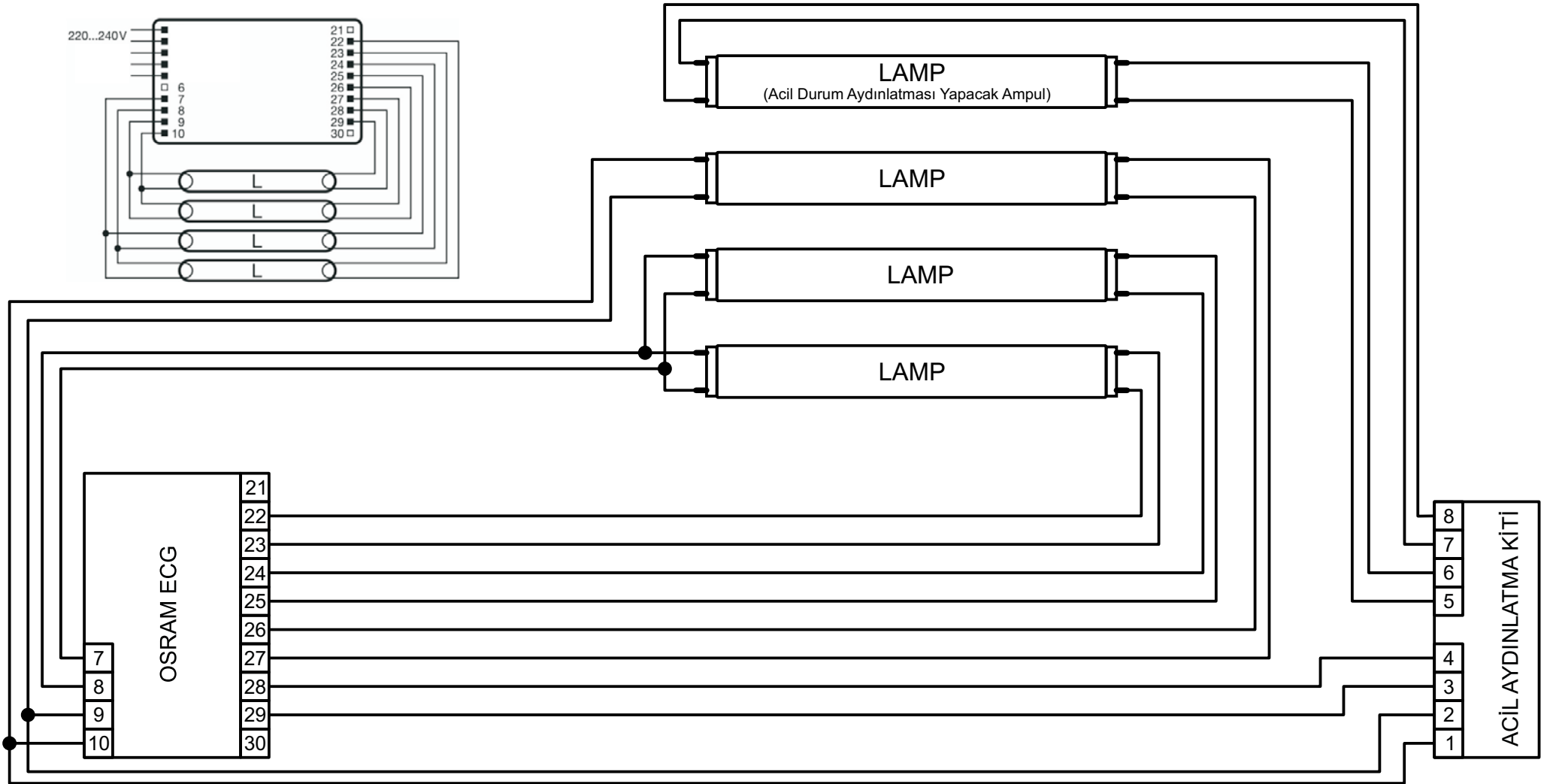

QTi-T/E 1X18-57 DIM

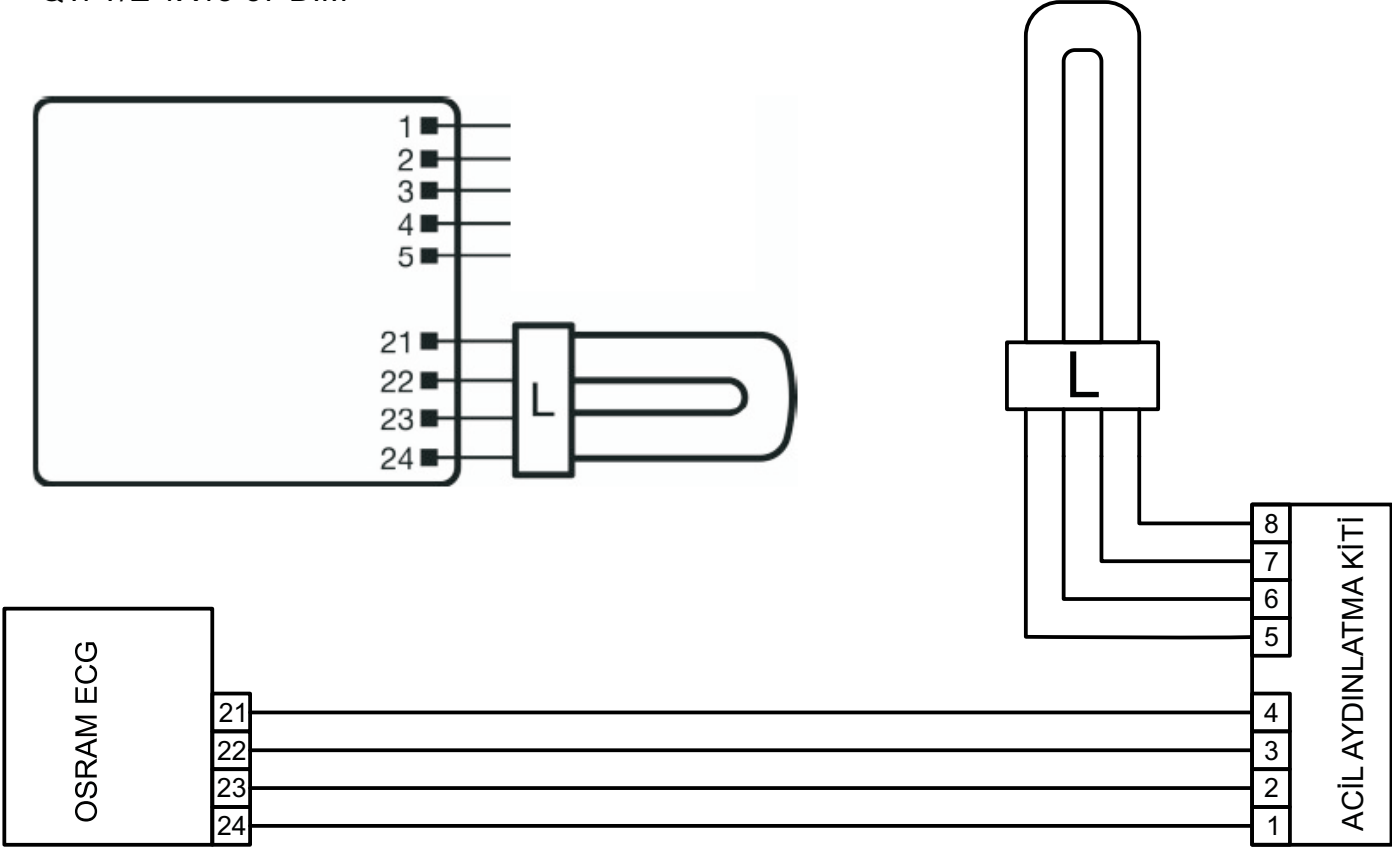

QTi-T-E 2X18-42 DIM

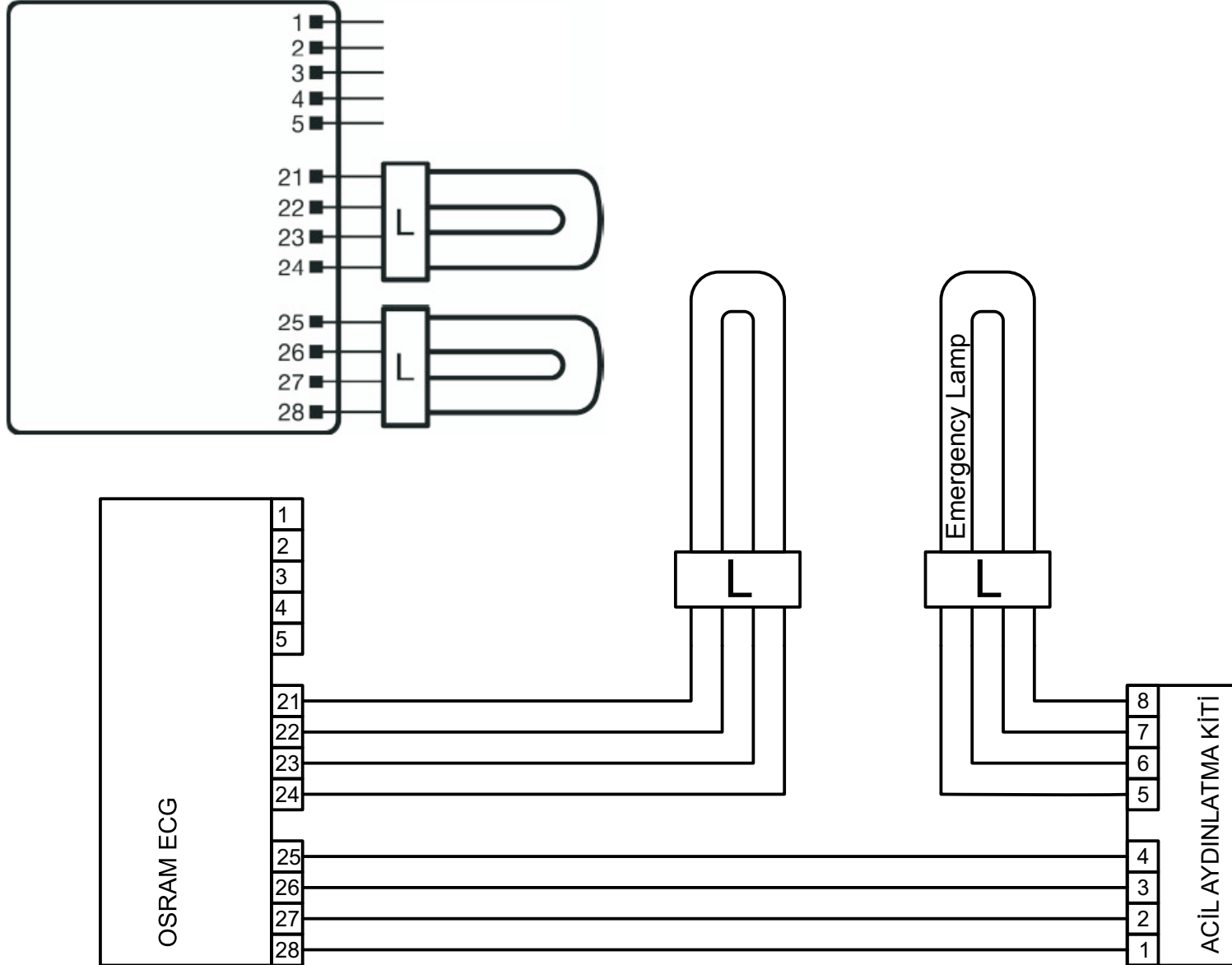

QTi-T/E DALI 1X18-57 DIM

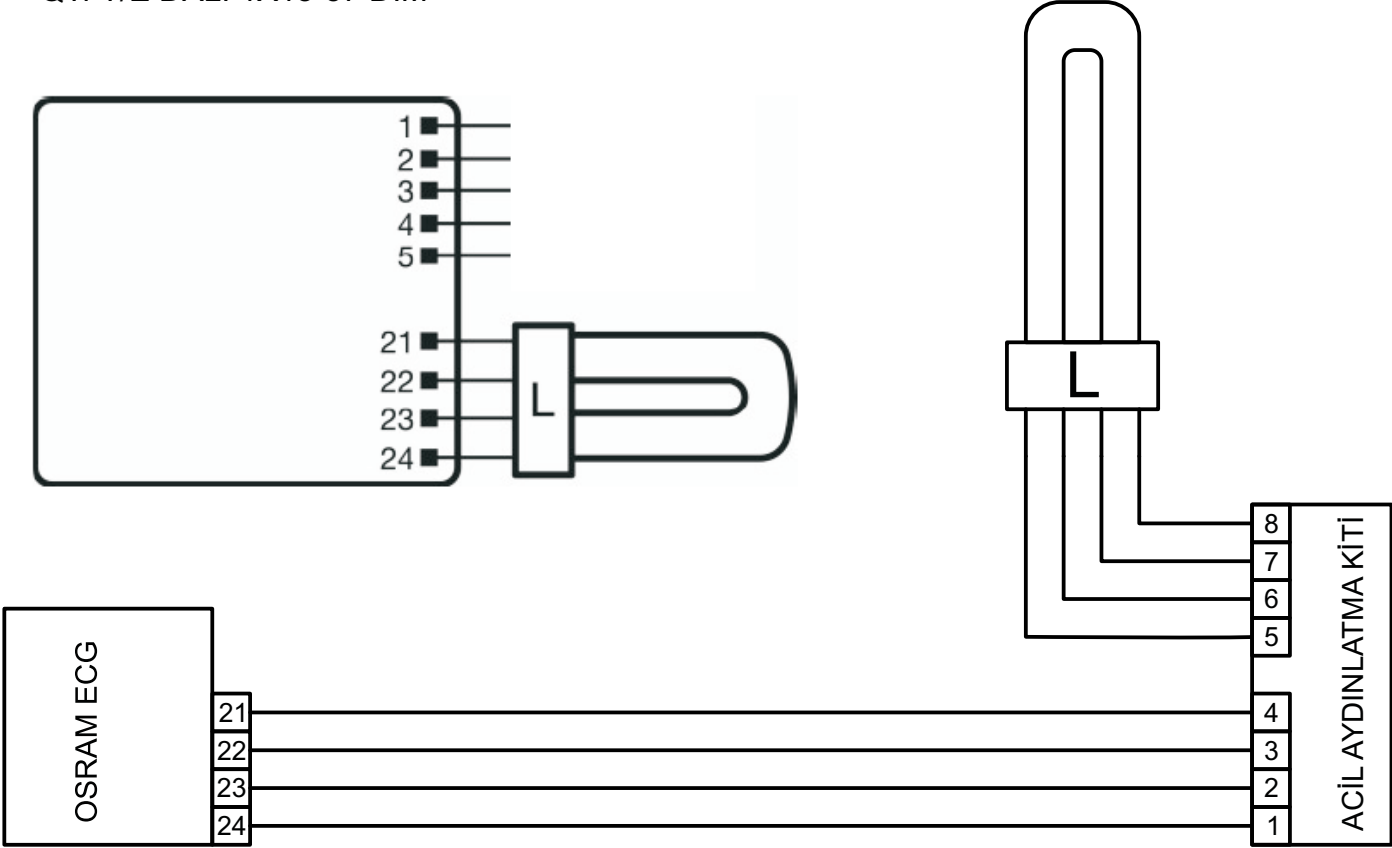

QTi-T-E DALI 2X18-42 DIM

