

QTİ DALI 1x14-24 DIM

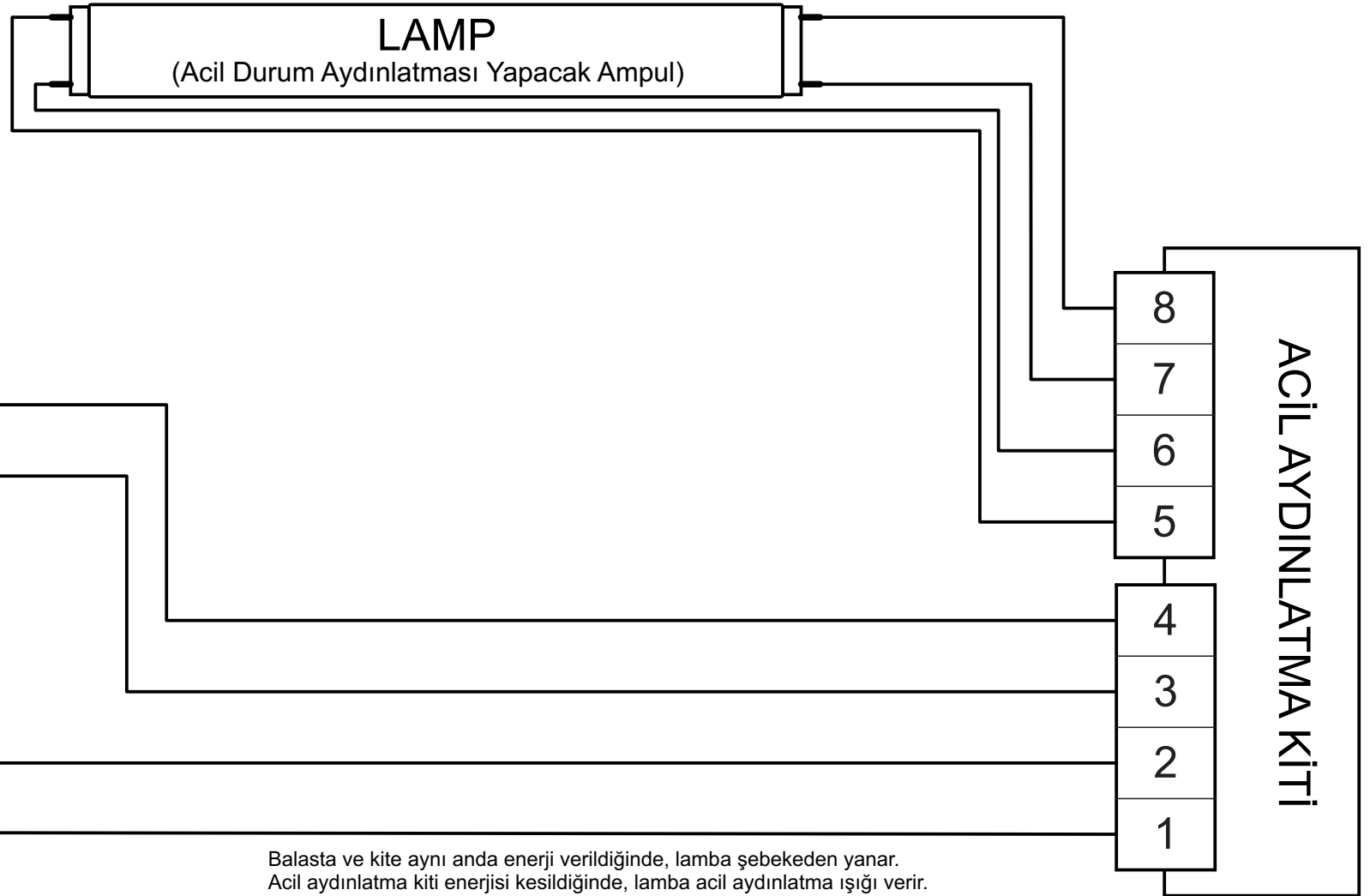

Balasta ve kite aynı anda enerji verildiğinde, lamba şebekeden yanar.
Acil aydınlatma kiti enerjisi kesildiğinde, lamba acil aydınlatma ışığı verir.

QTi DALI 1x18 DIM

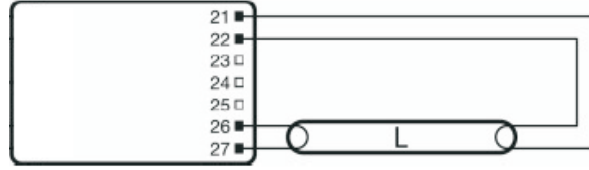
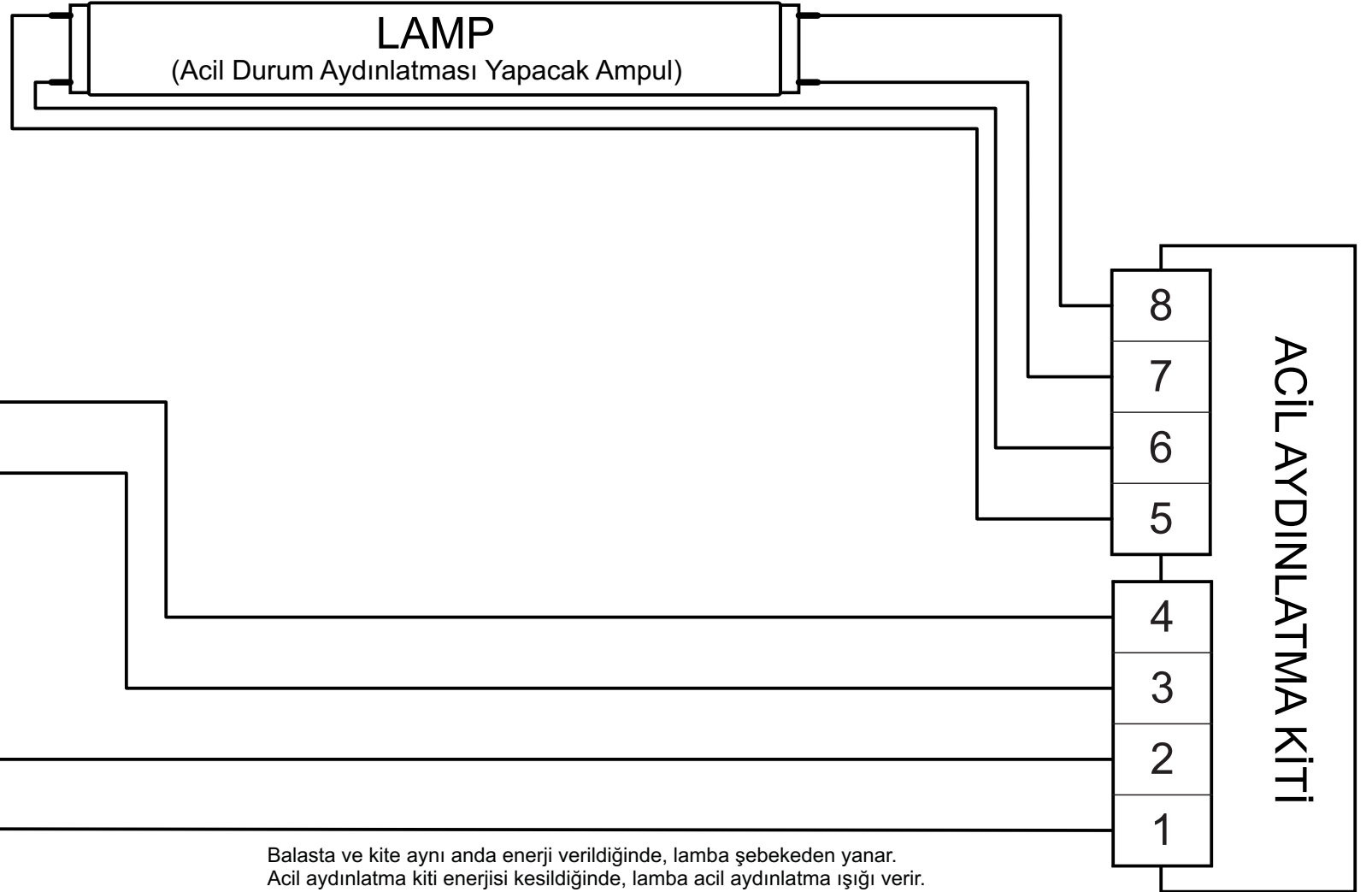
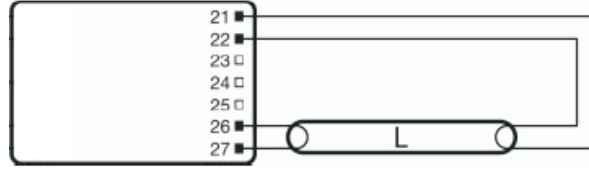

Balasta ve kite aynı anda enerji verildiğinde, lamba şebekeden yanar.
Acil aydınlatma kiti enerjisi kesildiğinde, lamba acil aydınlatma ışığı verir.

QTi DALI 1x21-39 DIM

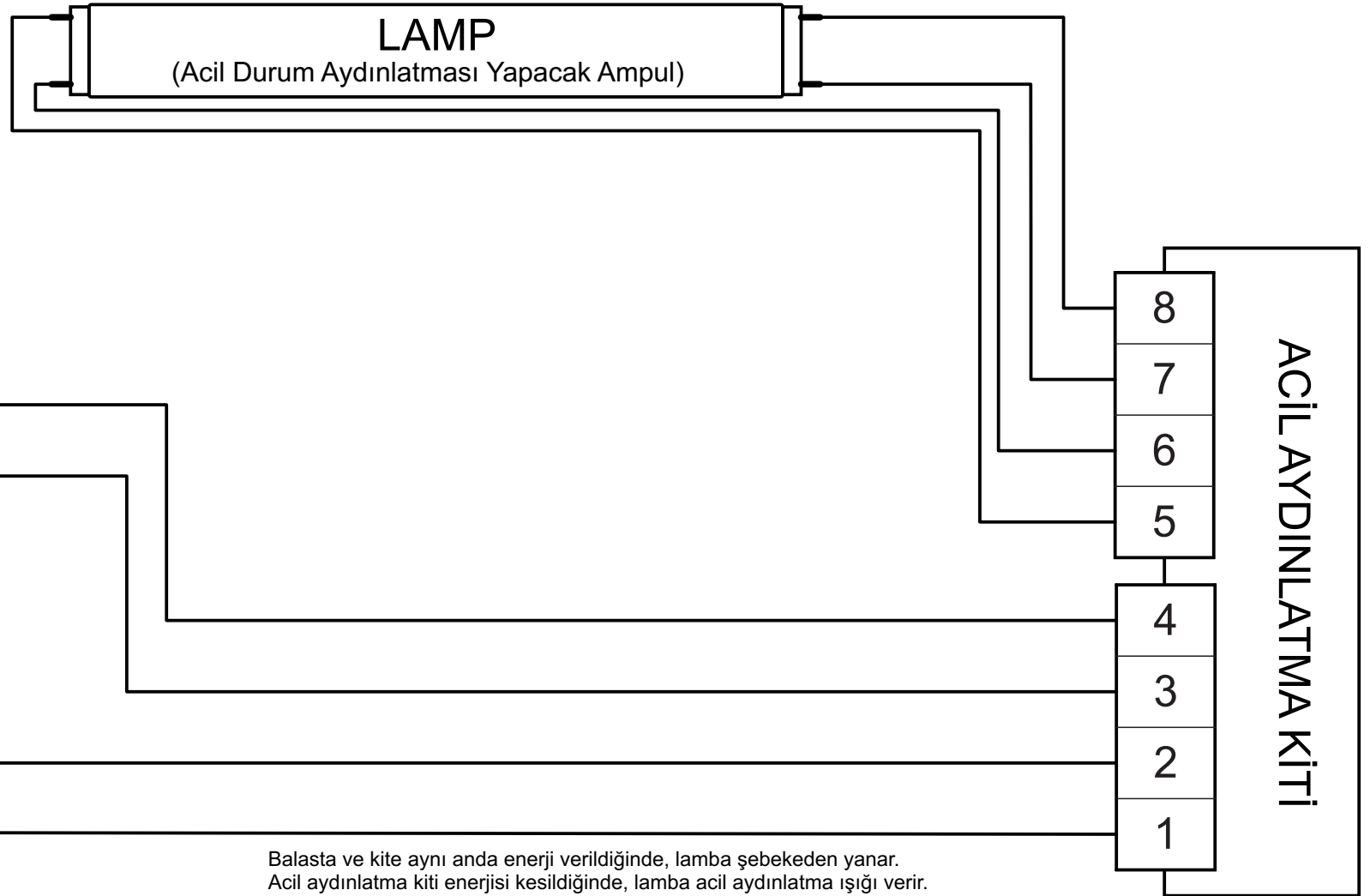
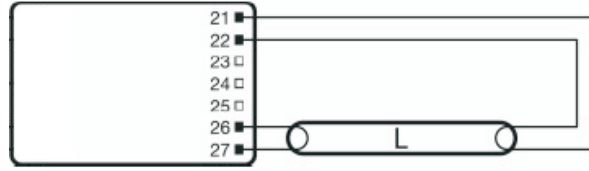

Balasta ve kite aynı anda enerji verildiğinde, lamba şebekeden yanar.
Acil aydınlatma kiti enerjisi kesildiğinde, lamba acil aydınlatma ışığı verir.

QTi DALI 1x28-54 DIM

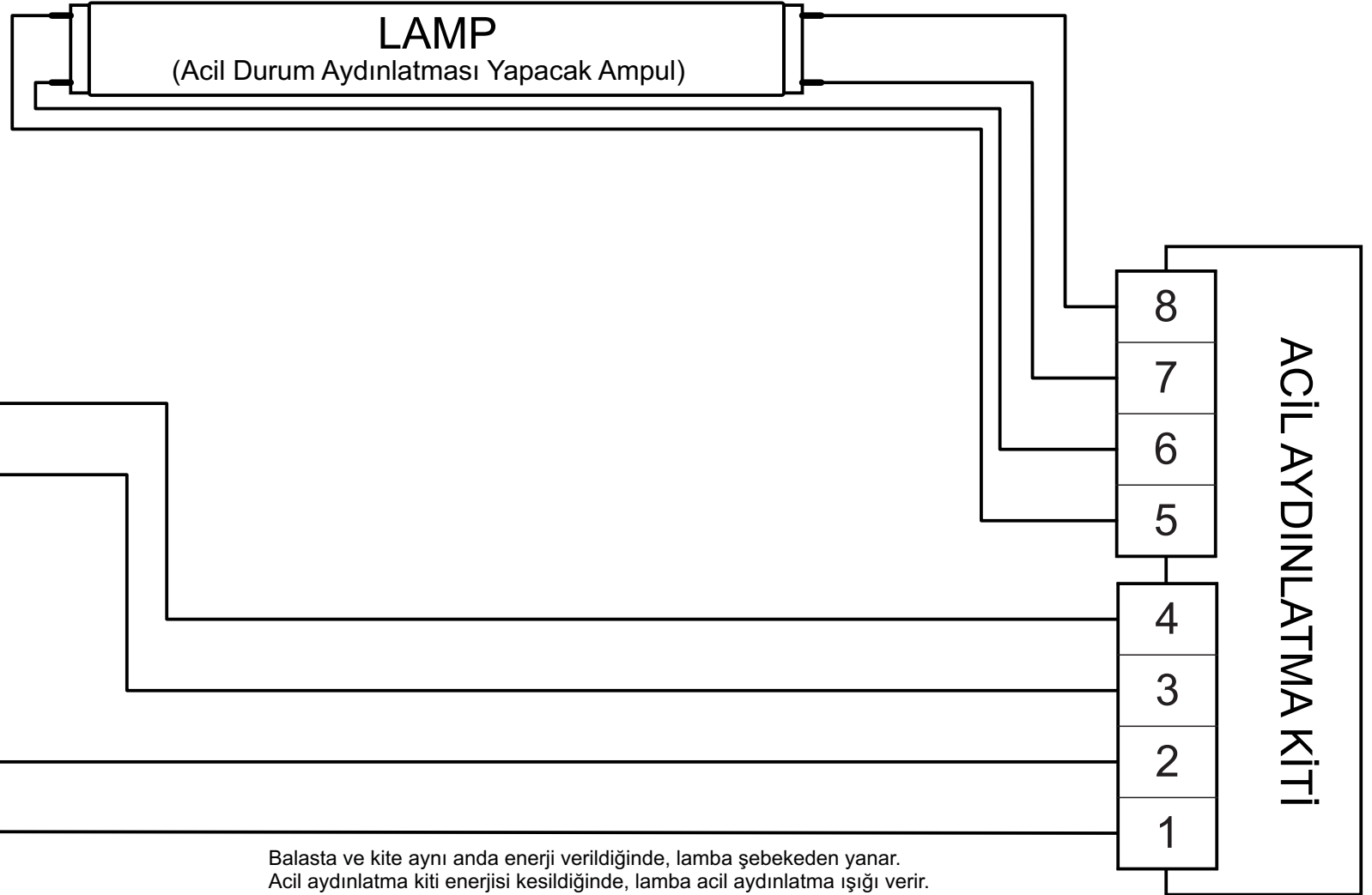
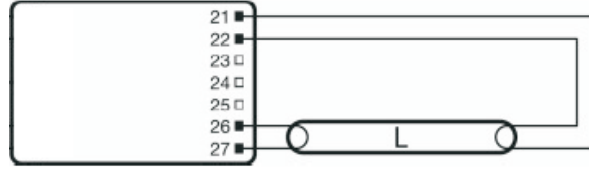

Balasta ve kite aynı anda enerji verildiğinde, lampa şebekeden yanar.
Acil aydınlatma kiti enerjisi kesildiğinde, lampa acil aydınlatma ışığı verir.

QTi DALI 1x36 DIM

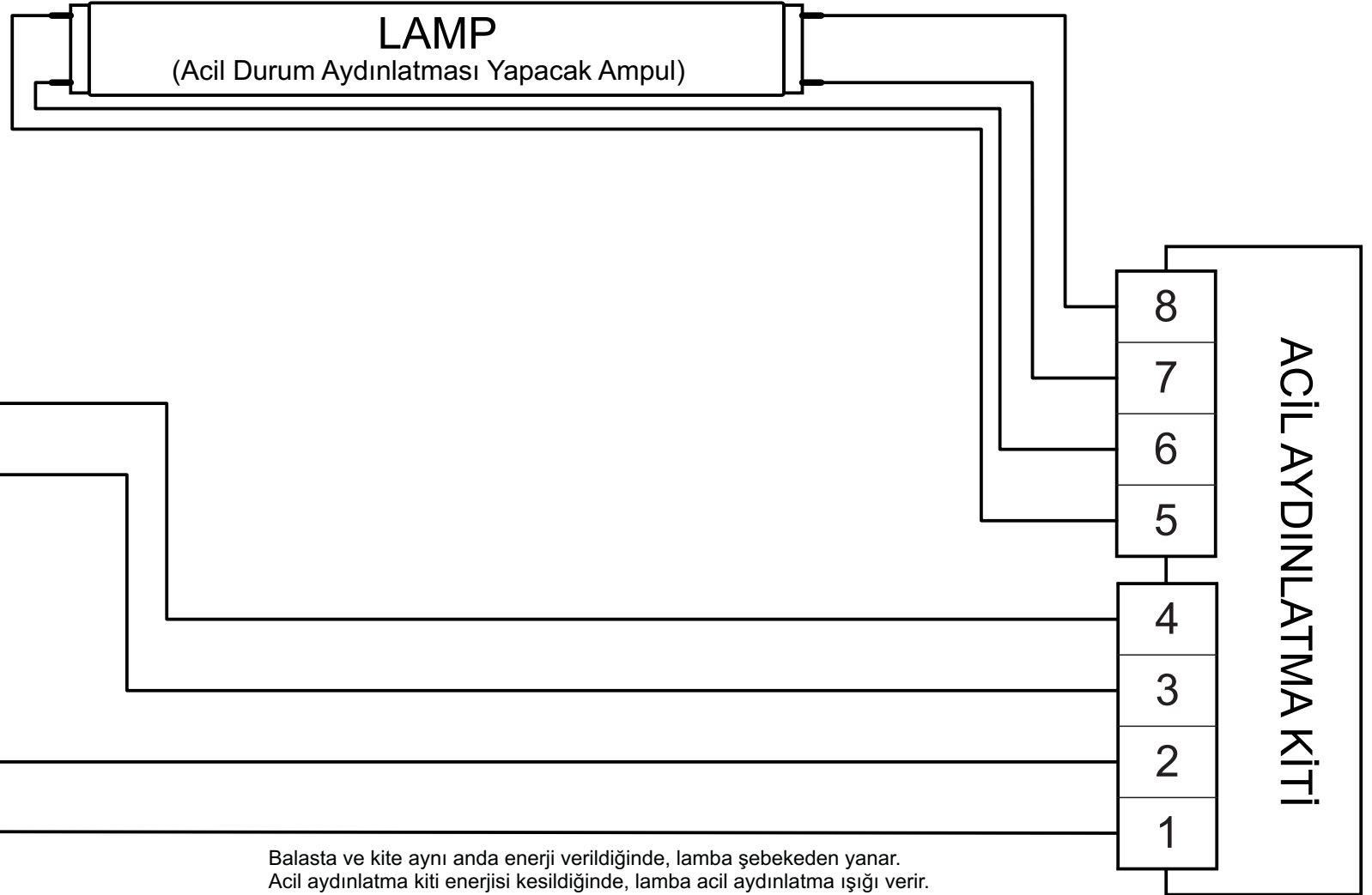
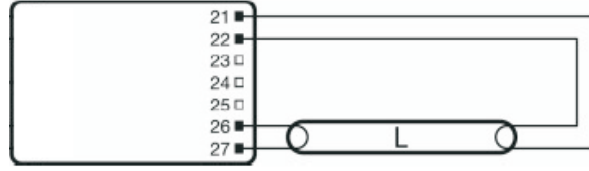

Balasta ve kite aynı anda enerji verildiğinde, lamba şebekeden yanar.
Acil aydınlatma kiti enerjisi kesildiğinde, lamba acil aydınlatma ışığı verir.

QTi DALI 1x58 DIM

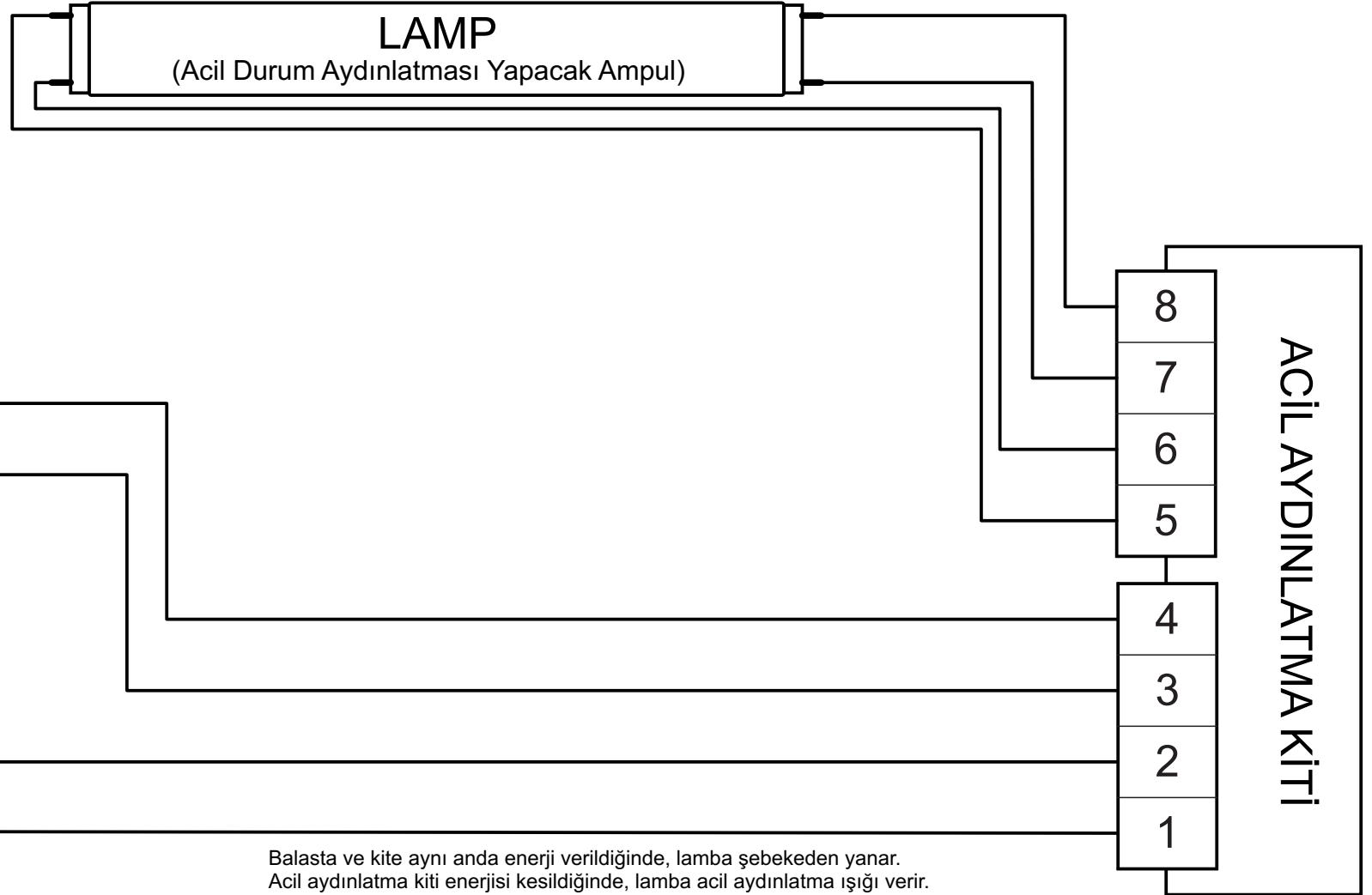
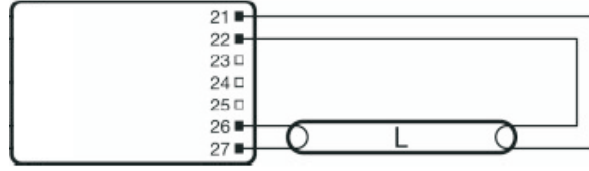

Balasta ve kite aynı anda enerji verildiğinde, lamba şebekeden yanar.
Acil aydınlatma kiti enerjisi kesildiğinde, lamba acil aydınlatma ışığı verir.

Qti DALI 2x14/24 DIM

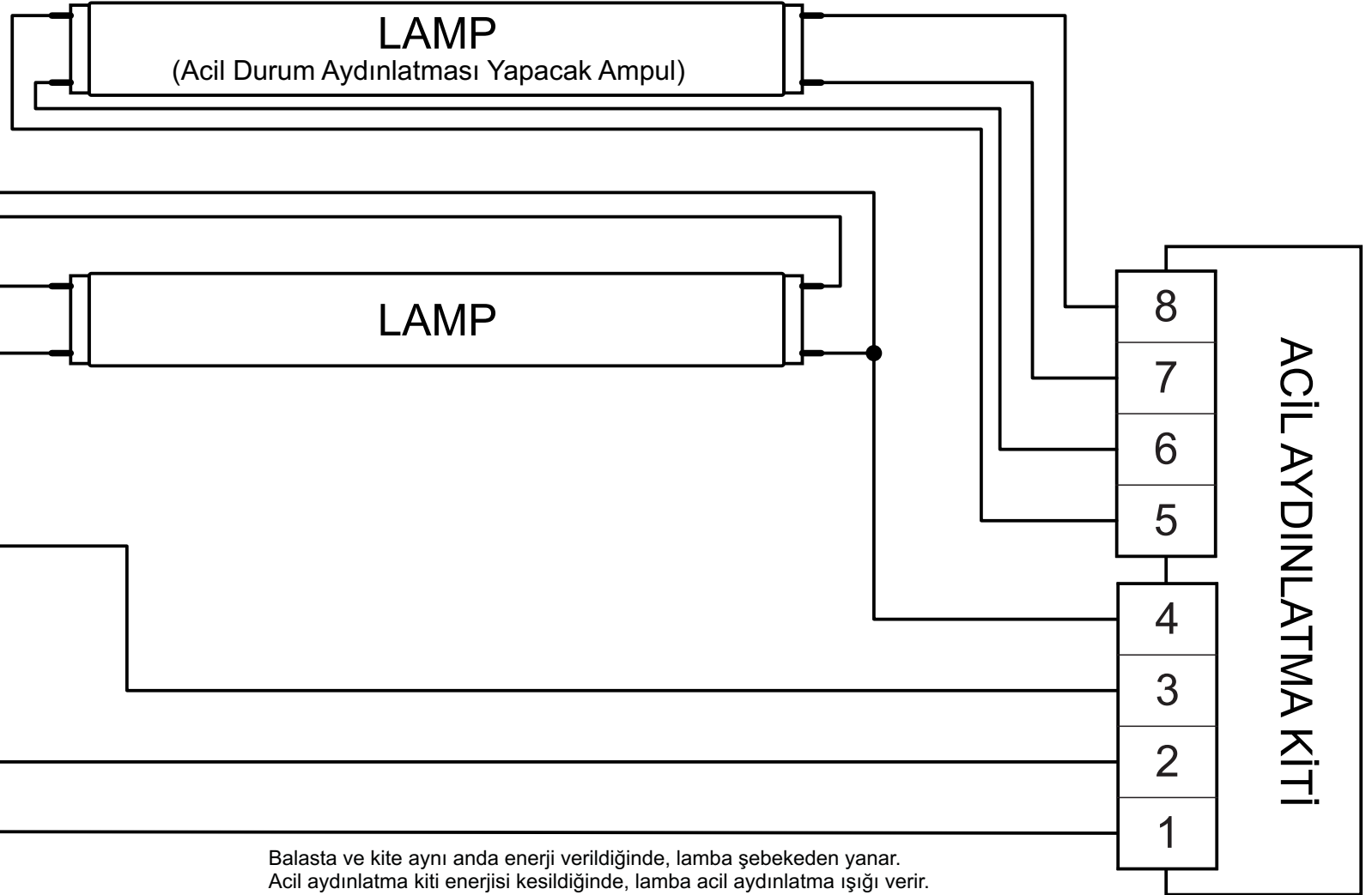
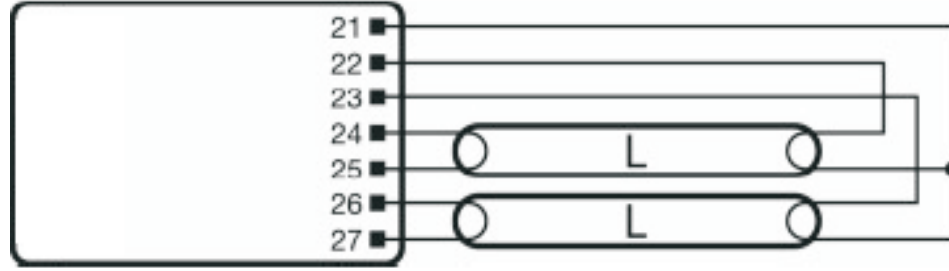

Balasta ve kite aynı anda enerji verildiğinde, lamba şebekeden yanar.
Acil aydınlatma kiti enerjisi kesildiğinde, lamba acil aydınlatma ışığı verir.

QTi DALI 2x18 DIM

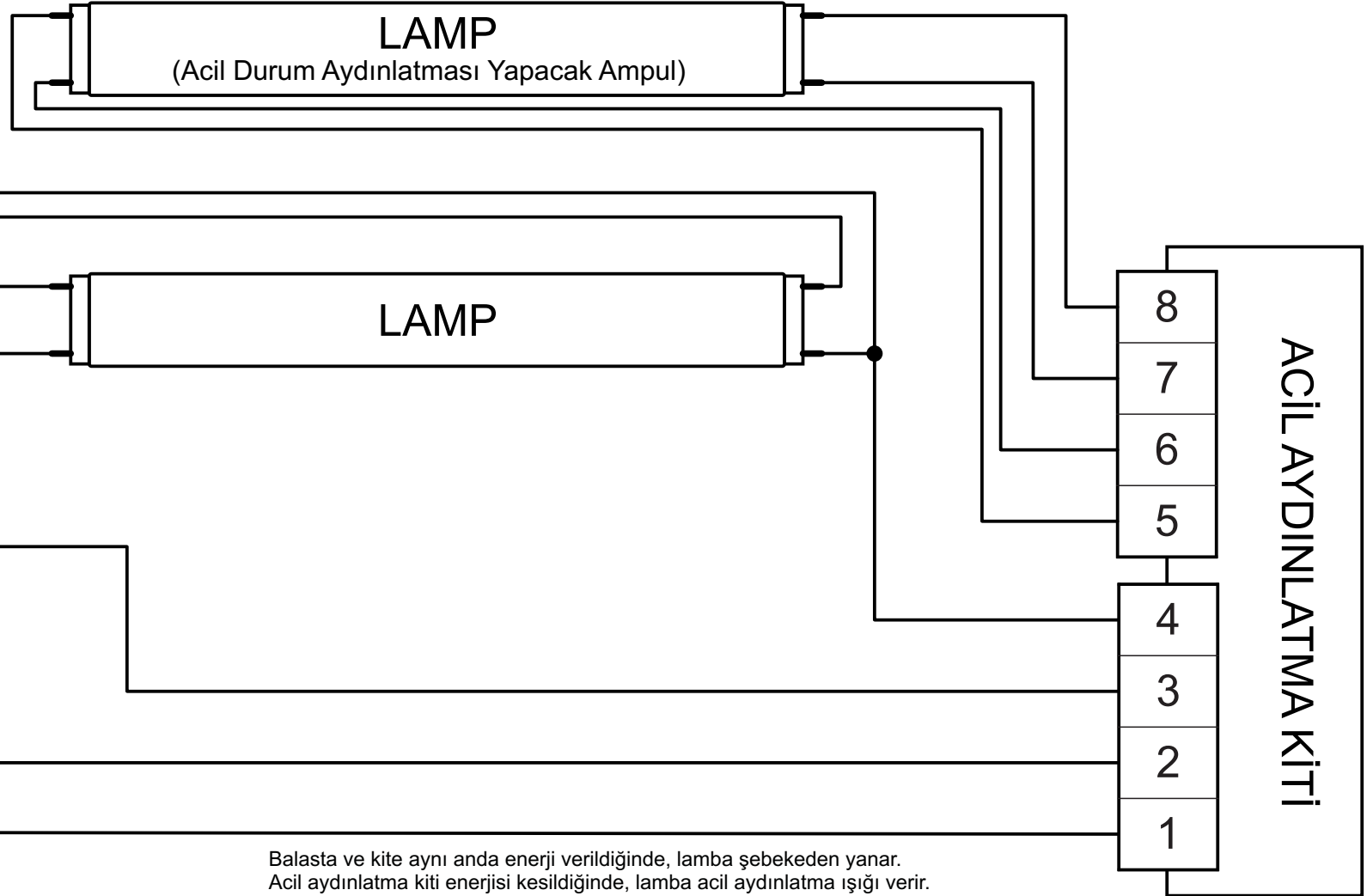
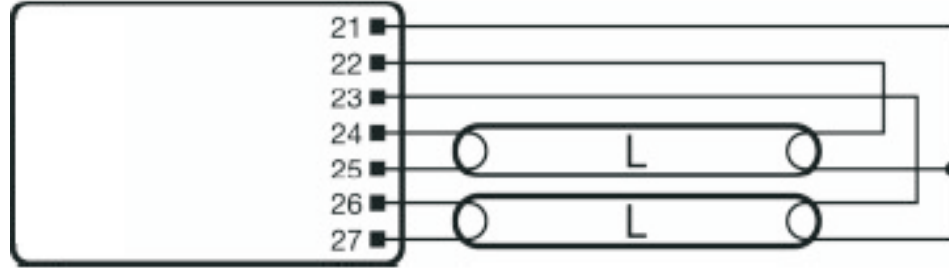

Balasta ve kite aynı anda enerji verildiğinde, lamba şebekeden yanar.
Acil aydınlatma kiti enerjisi kesildiğinde, lamba acil aydınlatma ışığı verir.

QTi DALI 2x21-39 DIM

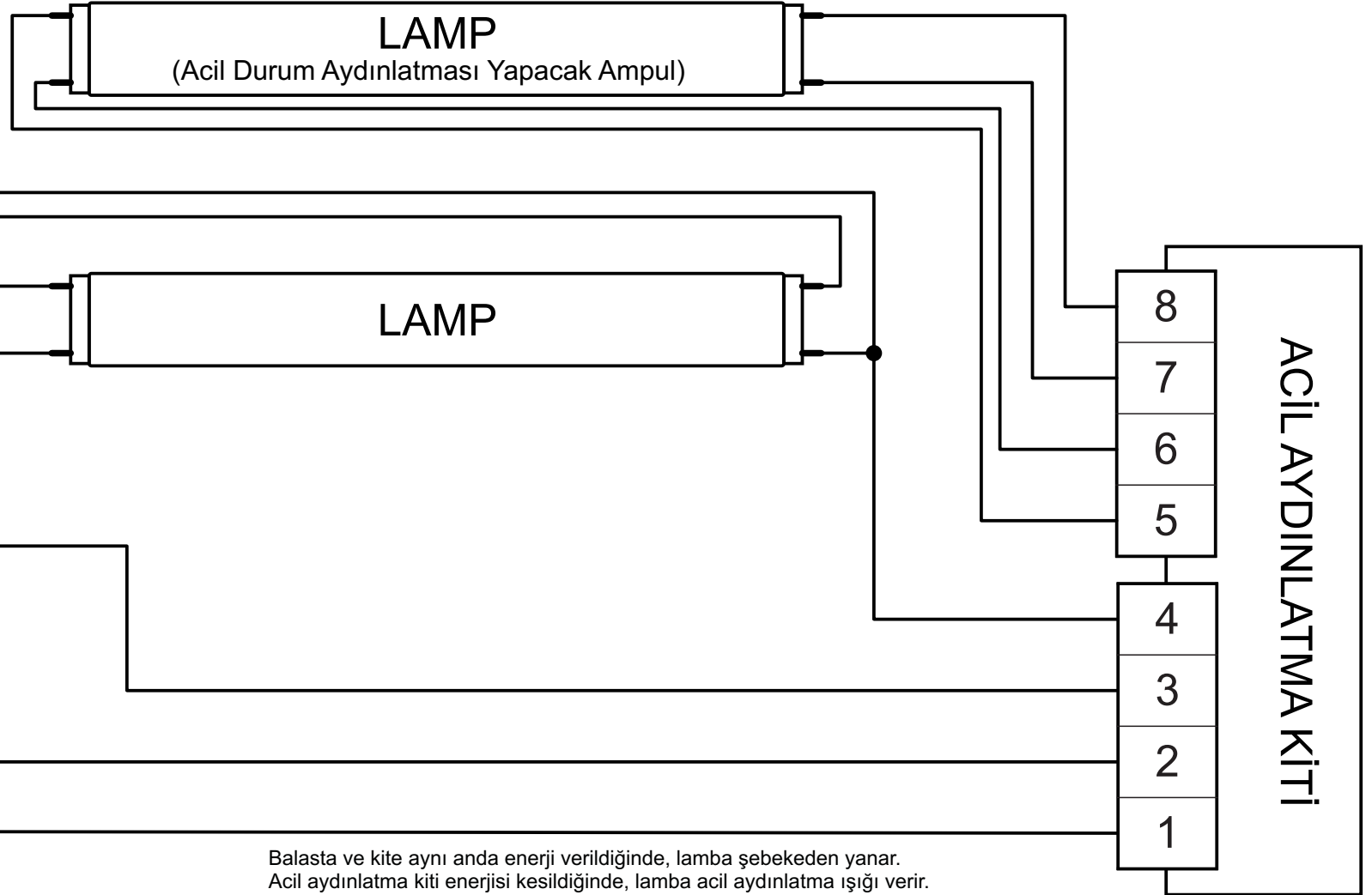
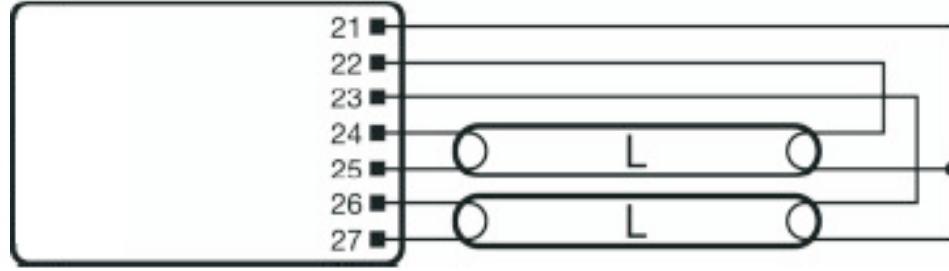

Balasta ve kite aynı anda enerji verildiğinde, lamba şebekeden yanar.
Acil aydınlatma kiti enerjisi kesildiğinde, lamba acil aydınlatma ışığı verir.

QTi DALI 2x28-54 DIM

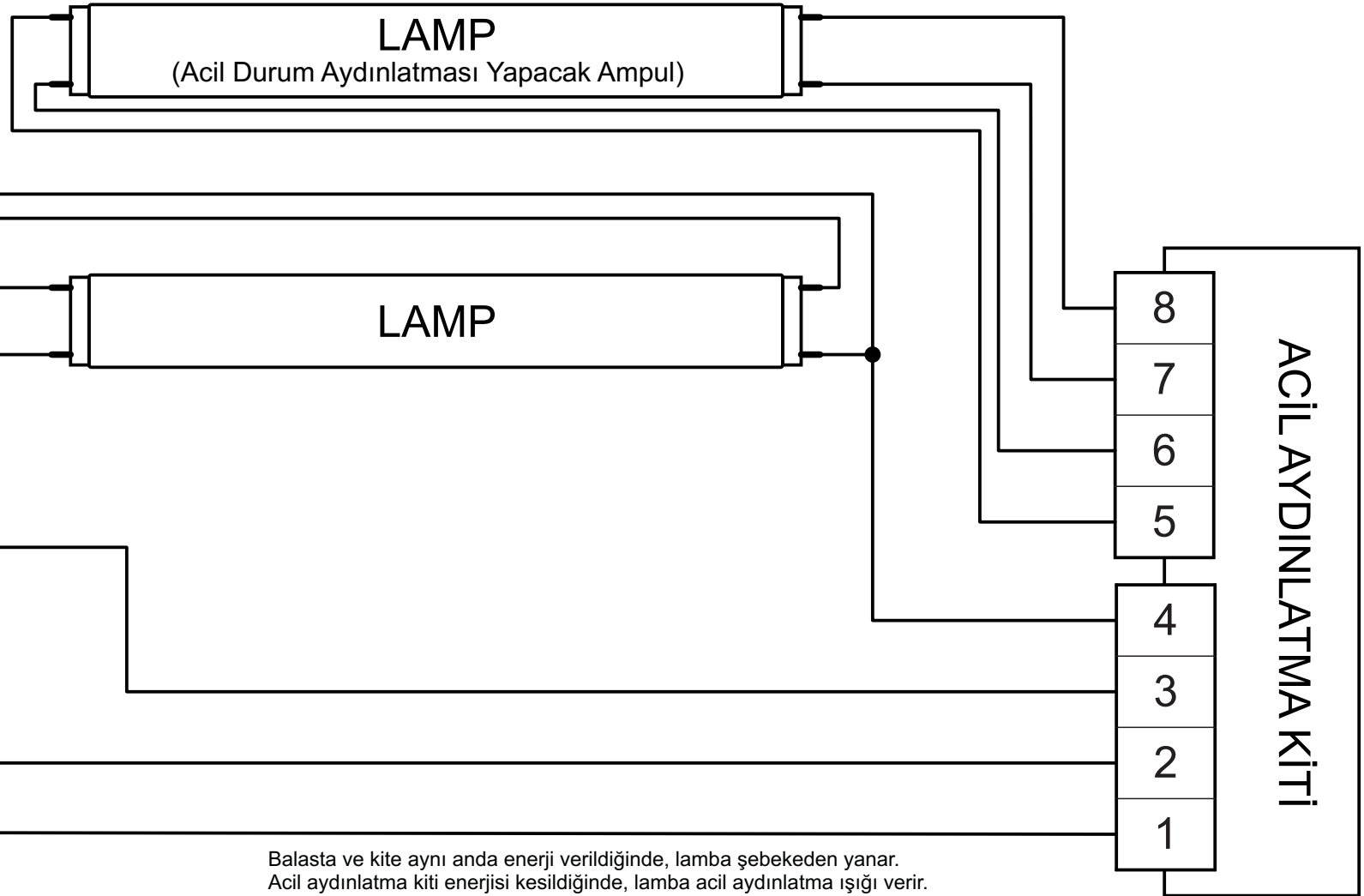
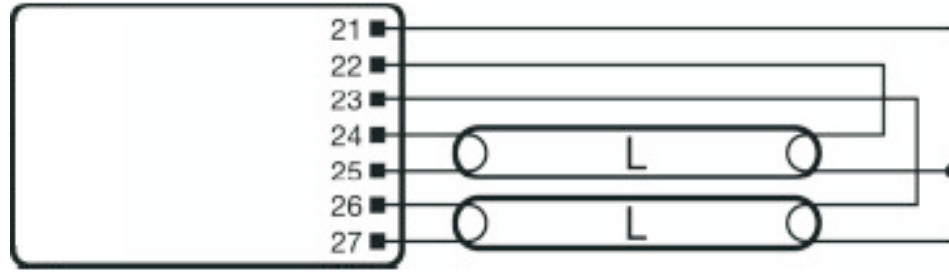

Balasta ve kite aynı anda enerji verildiğinde, lamba şebekeden yanar.
Acil aydınlatma kiti enerjisi kesildiğinde, lamba acil aydınlatma ışığı verir.

QTi DALI 2x35-49 DIM

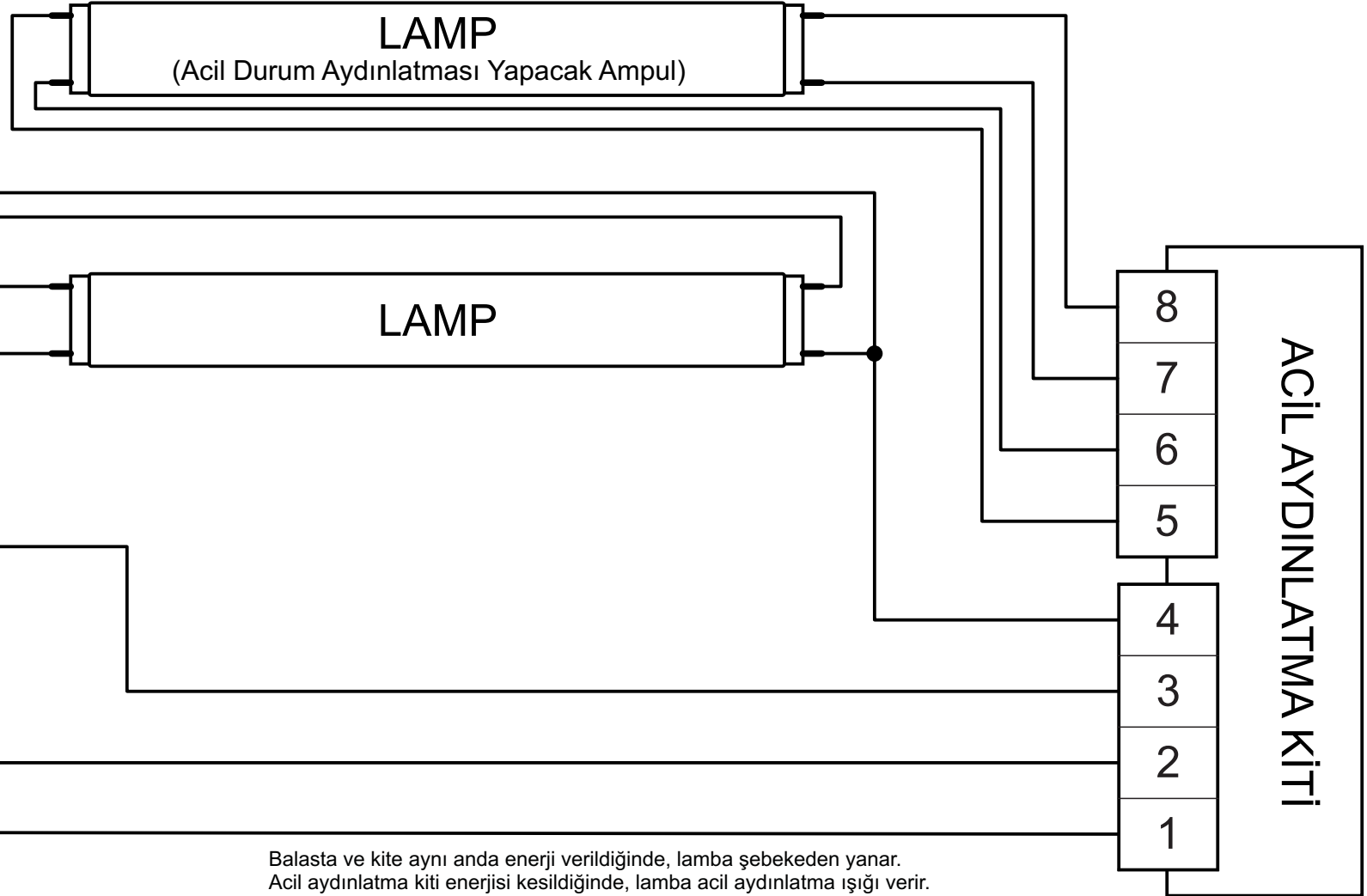
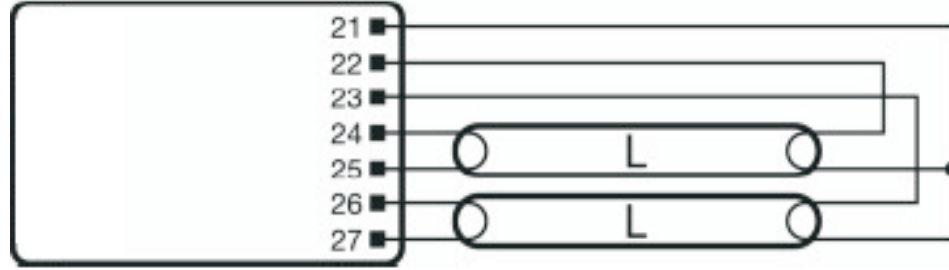

Balasta ve kite aynı anda enerji verildiğinde, lamba şebekeden yanar.
Acil aydınlatma kiti enerjisi kesildiğinde, lamba acil aydınlatma ışığı verir.

QTİ DALI 2x35-49-80 DIM

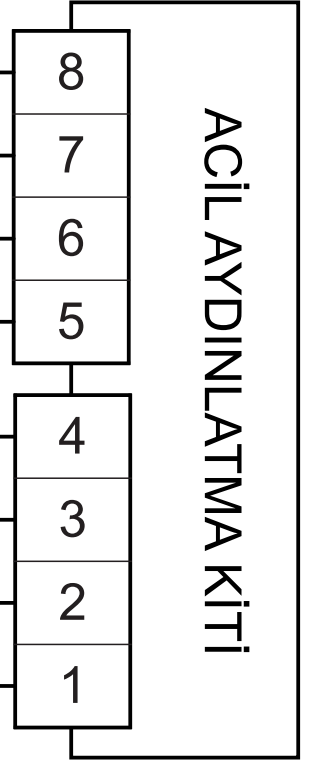
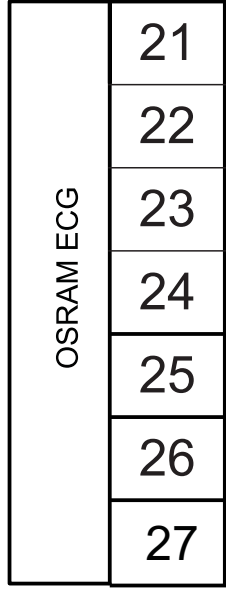
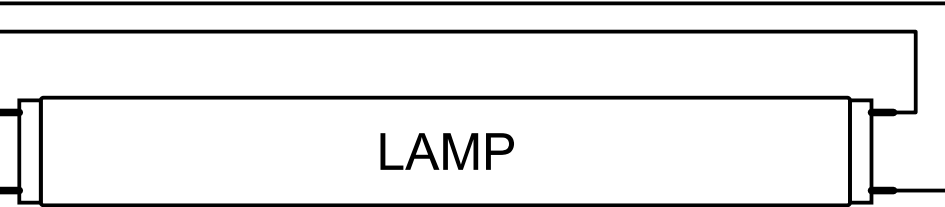
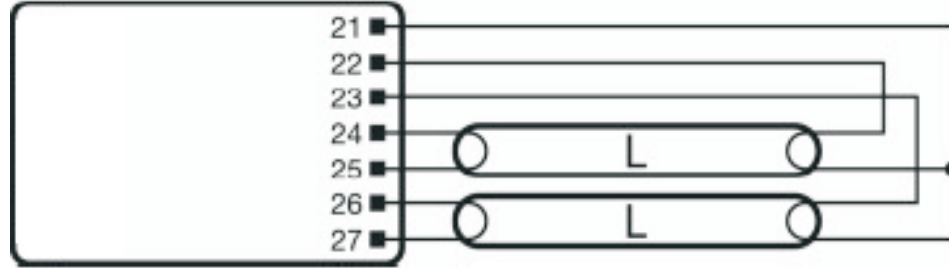

Balasta ve kite aynı anda enerji verildiğinde, lamba şebekeden yanar.
Acil aydınlatma kiti enerjisi kesildiğinde, lamba acil aydınlatma ışığı verir.

QTi DALI 2x36 DIM

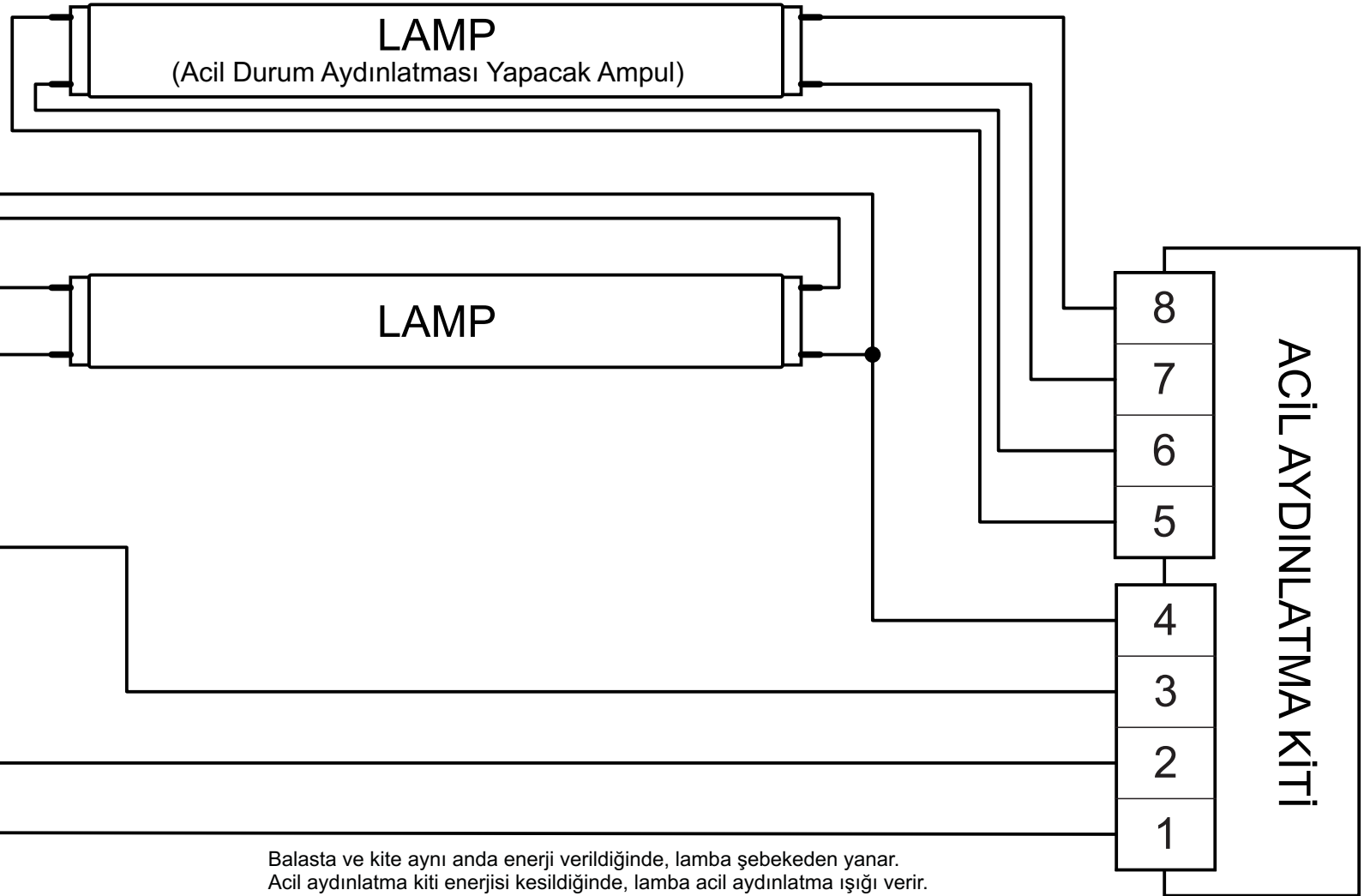
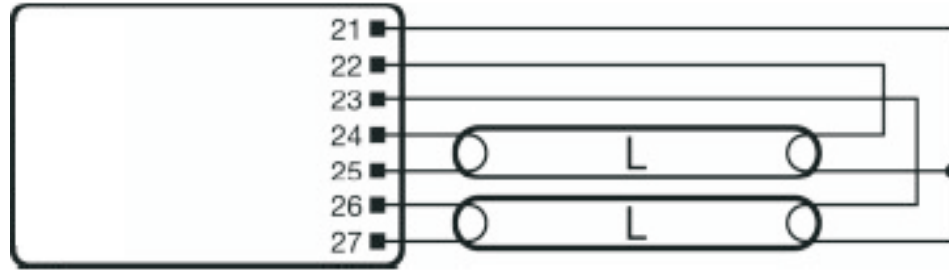

Balasta ve kite aynı anda enerji verildiğinde, lamba şebekeden yanar.
Acil aydınlatma kiti enerjisi kesildiğinde, lamba acil aydınlatma ışığı verir.

QTi DALI 2x58 DIM

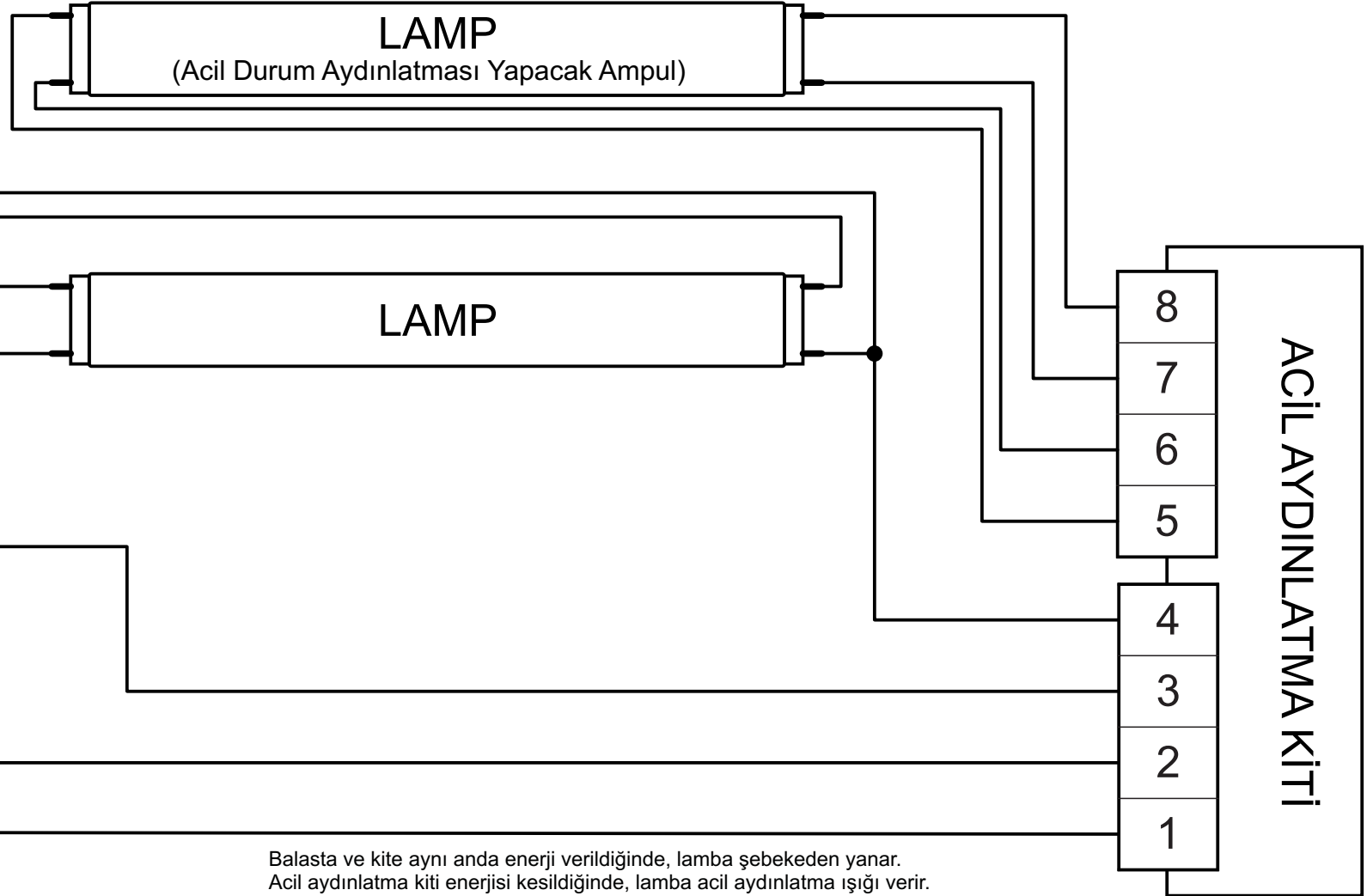
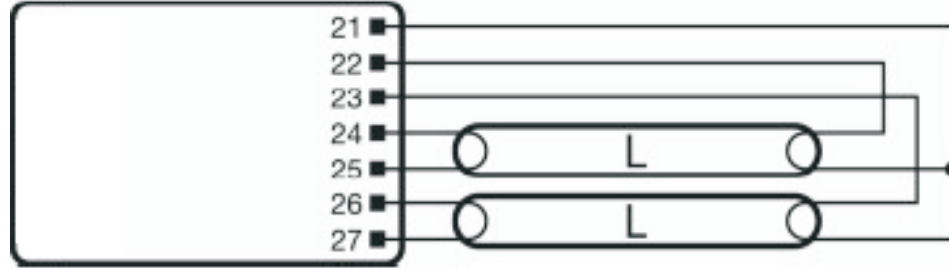

Balasta ve kite aynı anda enerji verildiğinde, lamba şebekeden yanar.
Acil aydınlatma kiti enerjisi kesildiğinde, lamba acil aydınlatma ışığı verir.

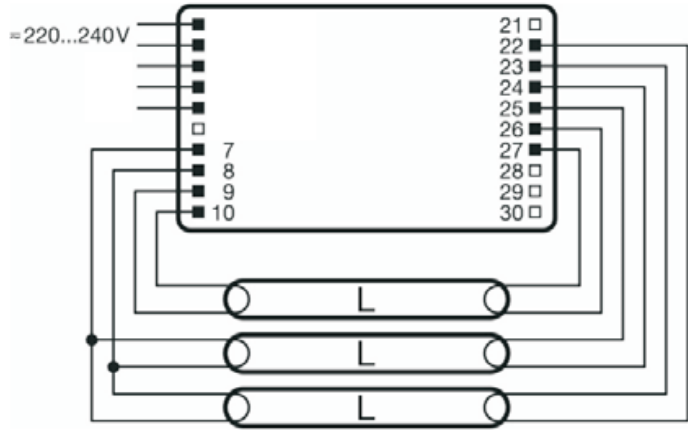

QTi DALI 3x14 DIM

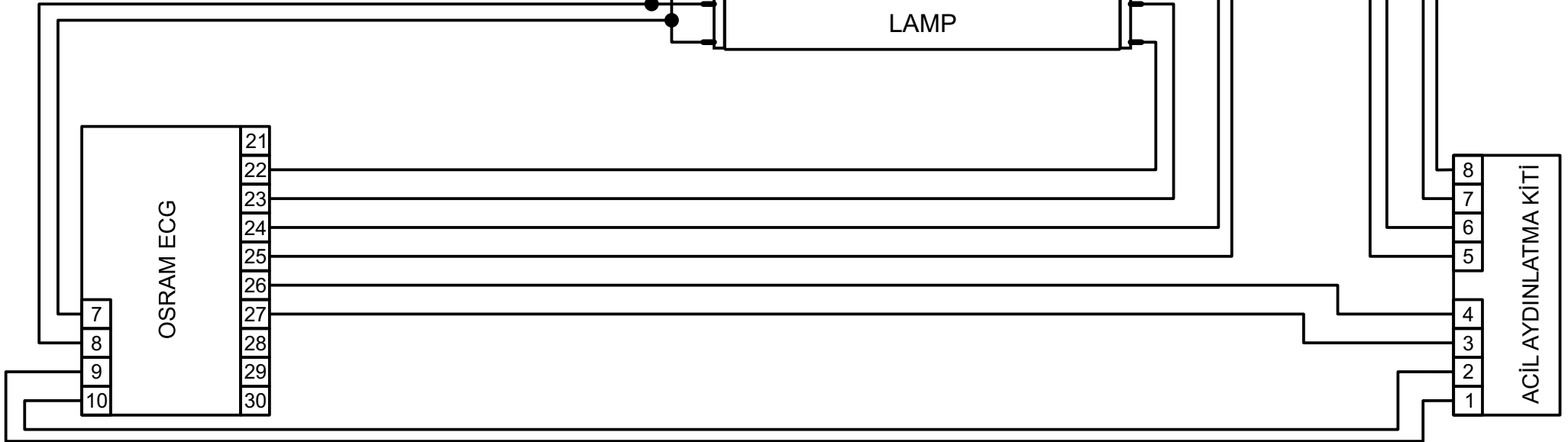
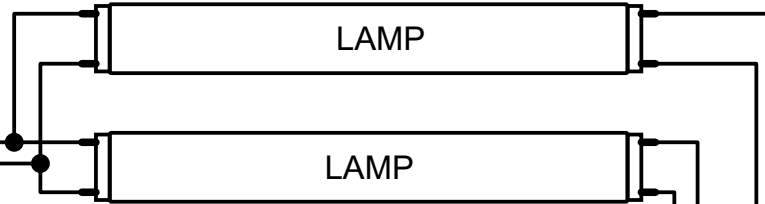
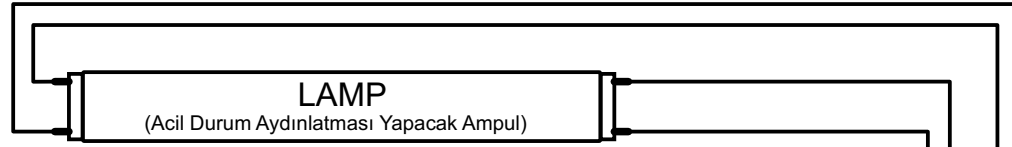

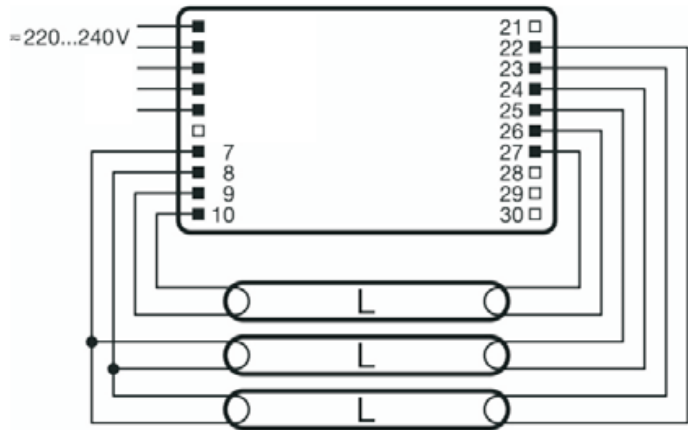

QTi DALI 3x18 DIM

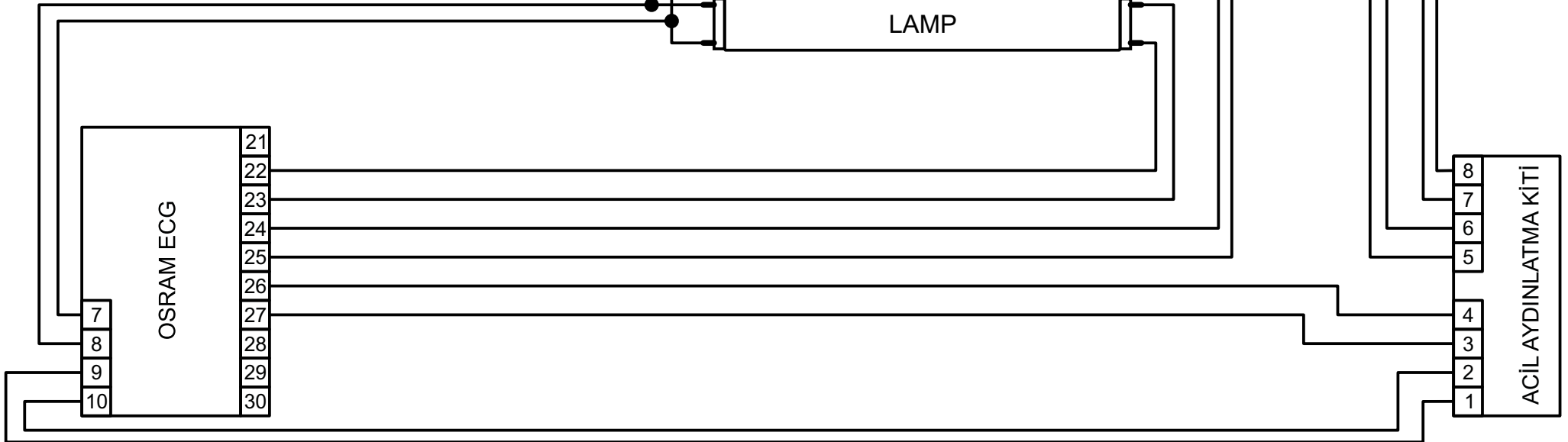
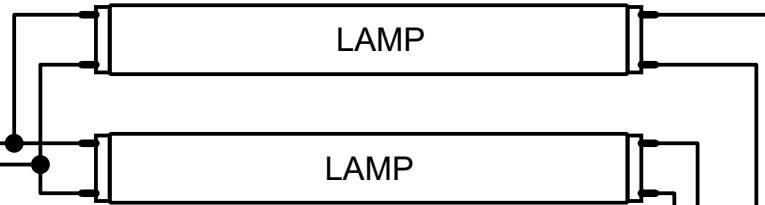
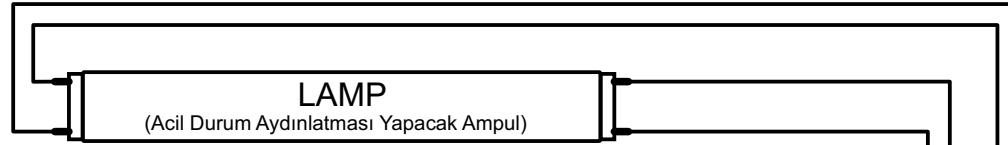

QTi DALI 4x14 DIM

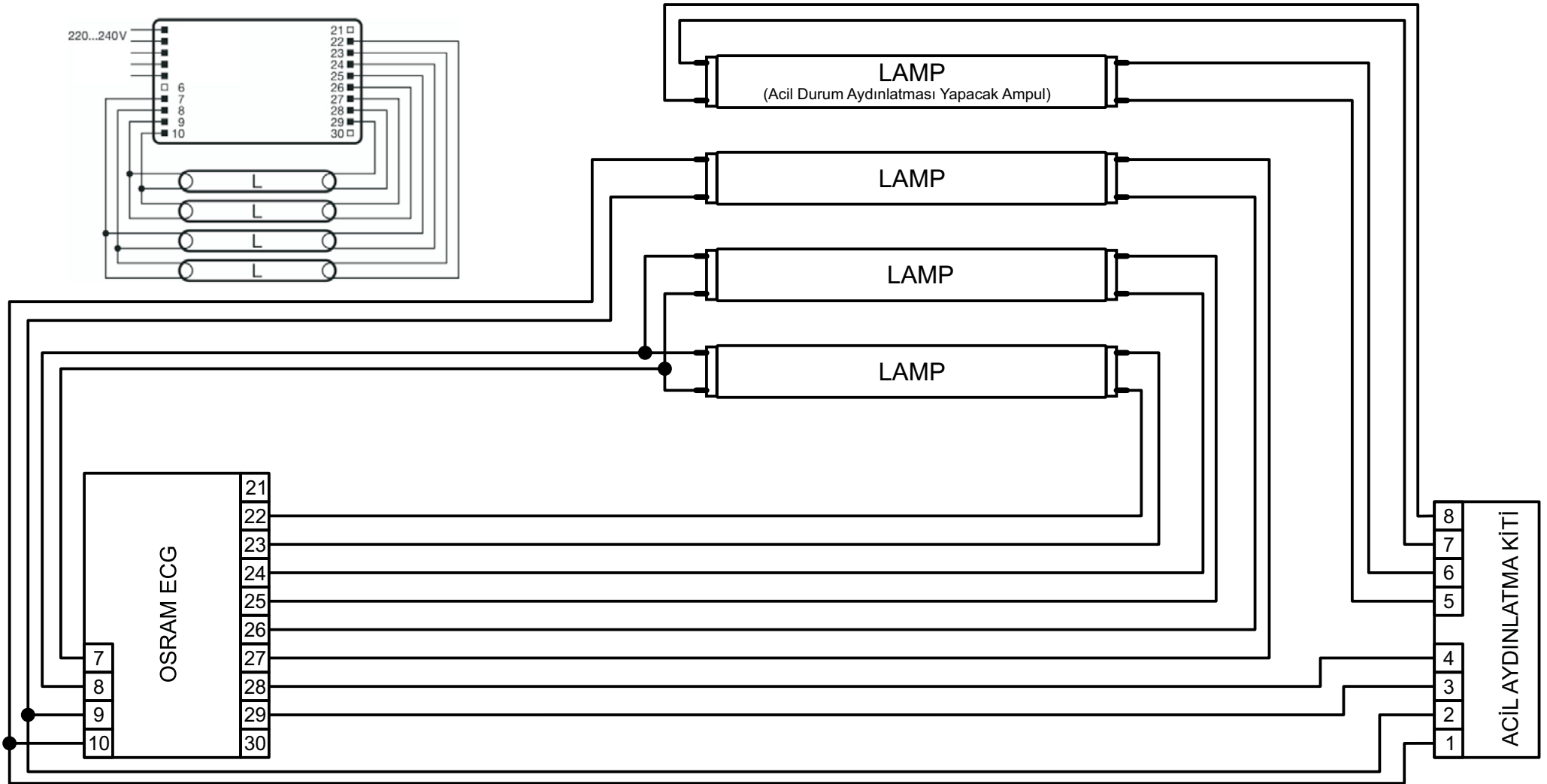

QTi DALI 4x18 DIM

