

QT-FIT8 2x18

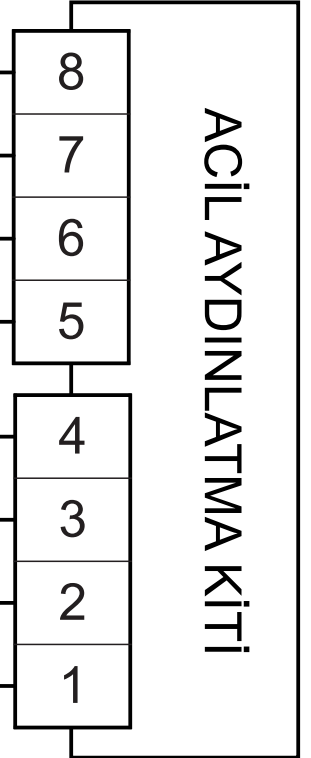

Balasta ve kite aynı anda enerji verildiğinde, lamba şebekeden yanar.
Acil aydınlatma kiti enerjisi kesildiğinde, lamba acil aydınlatma ışığı verir.

QT-FIT8 2x36

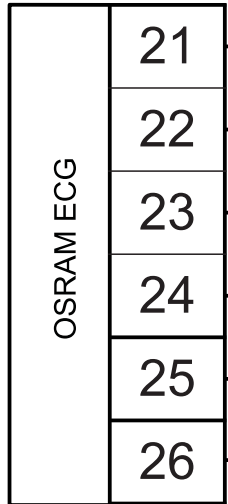
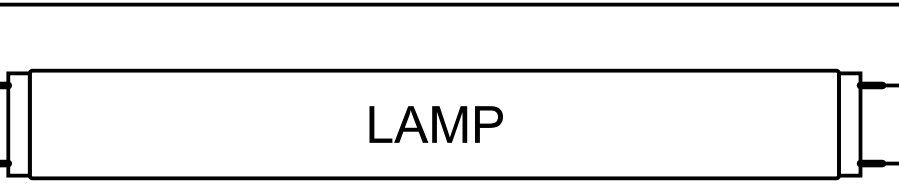
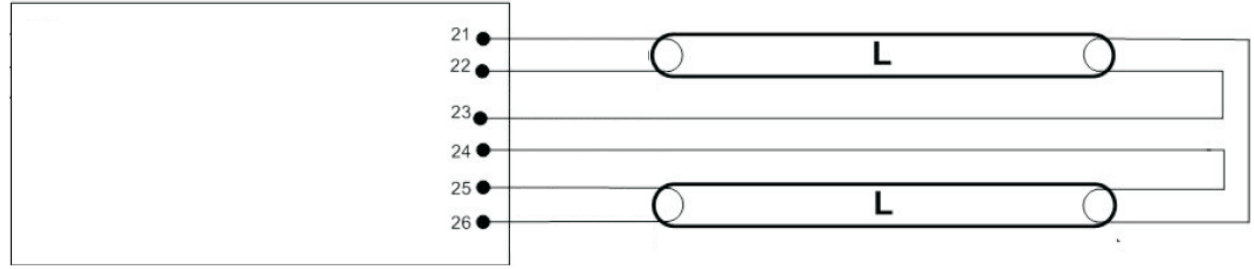
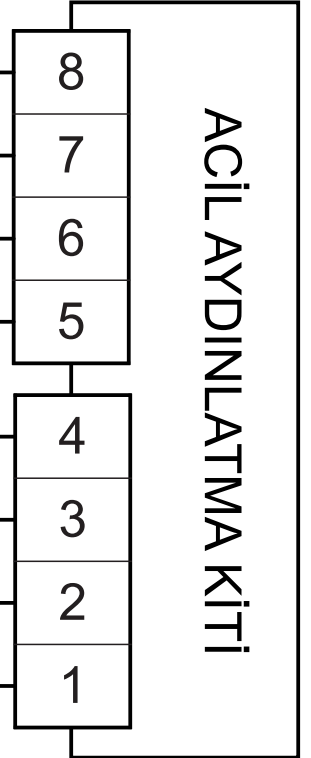
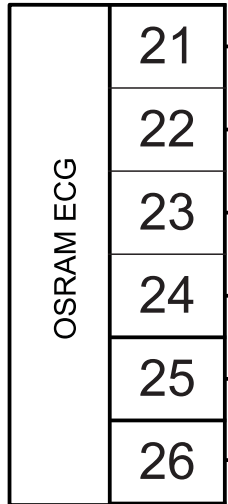
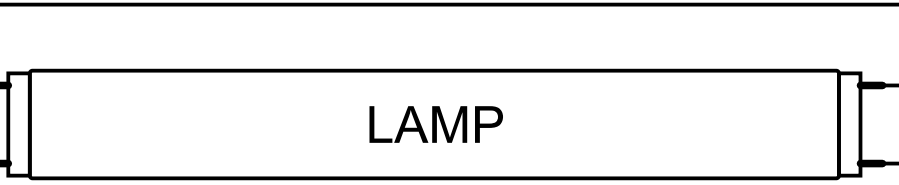
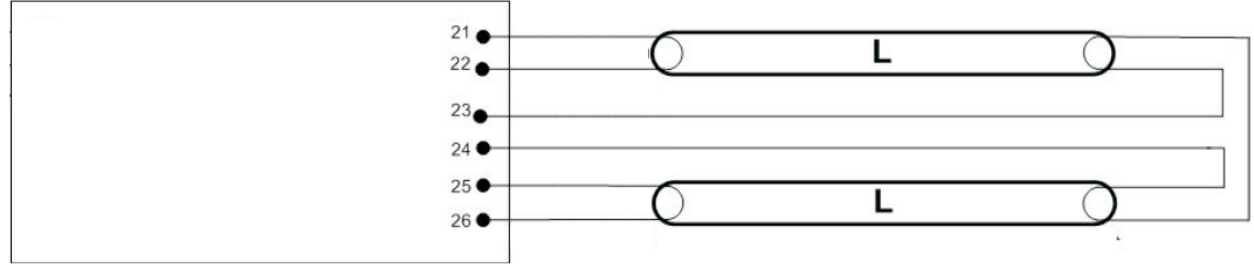

Balasta ve kite aynı anda enerji verildiğinde, lamba şebekeden yanar.
Acil aydınlatma kiti enerjisi kesildiğinde, lamba acil aydınlatma ışığı verir.

QT-FIT8 2x58

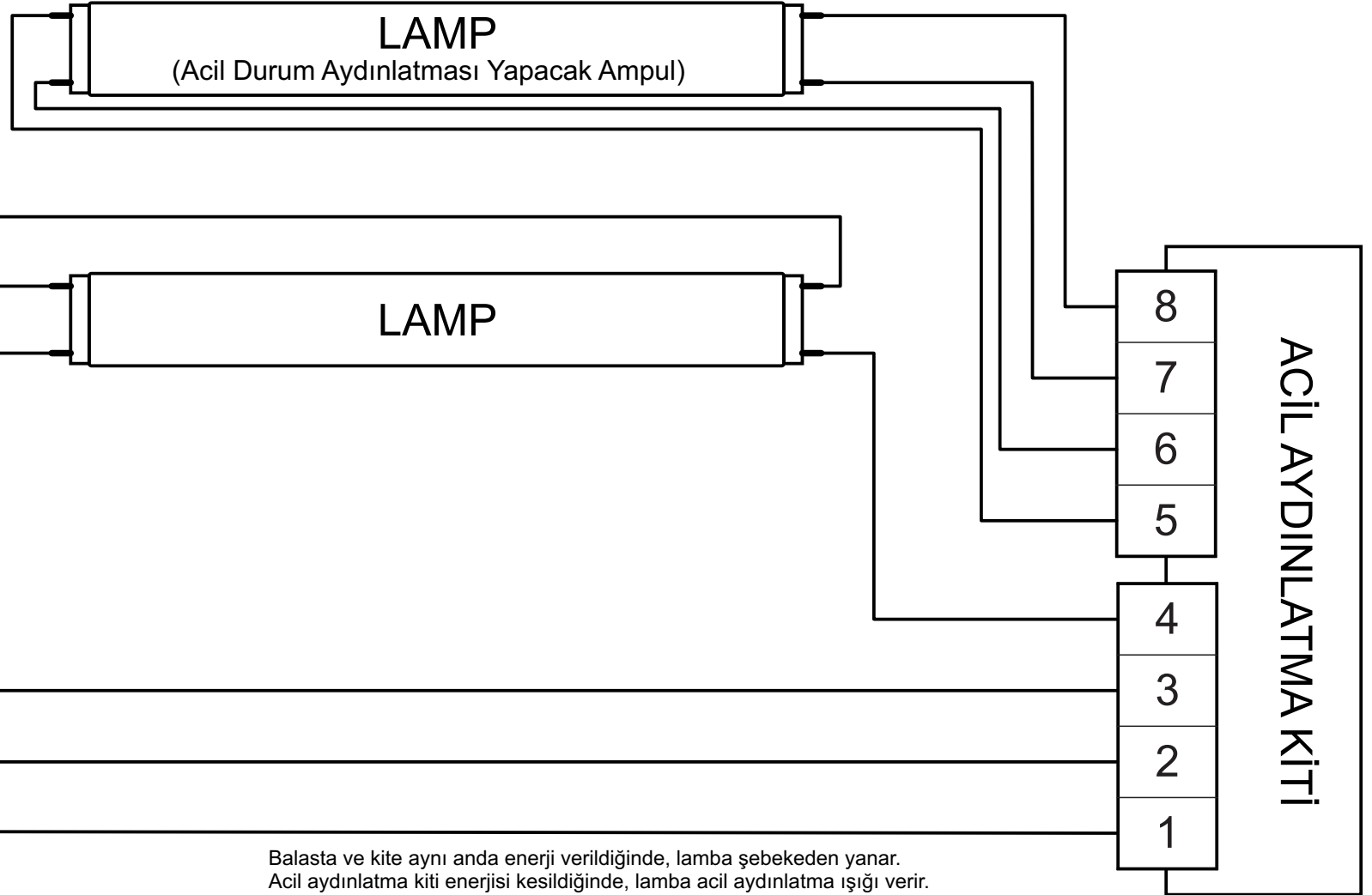
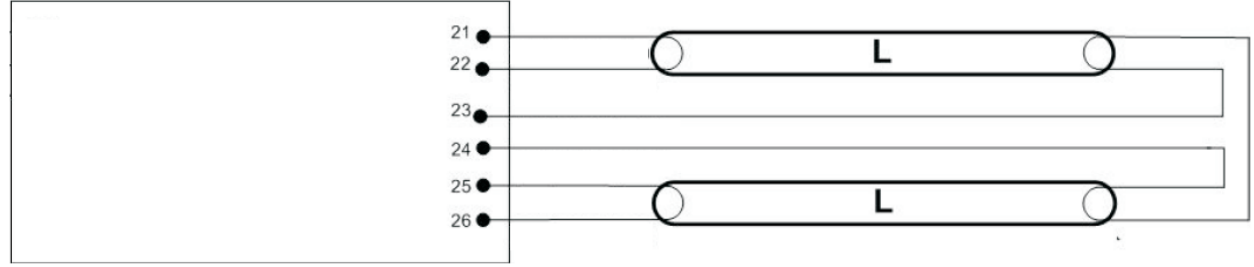

Balasta ve kite aynı anda enerji verildiğinde, lamba şebekeden yanar.
Acil aydınlatma kiti enerjisi kesildiğinde, lamba acil aydınlatma ışığı verir.

QT-FIT8 2x58-70

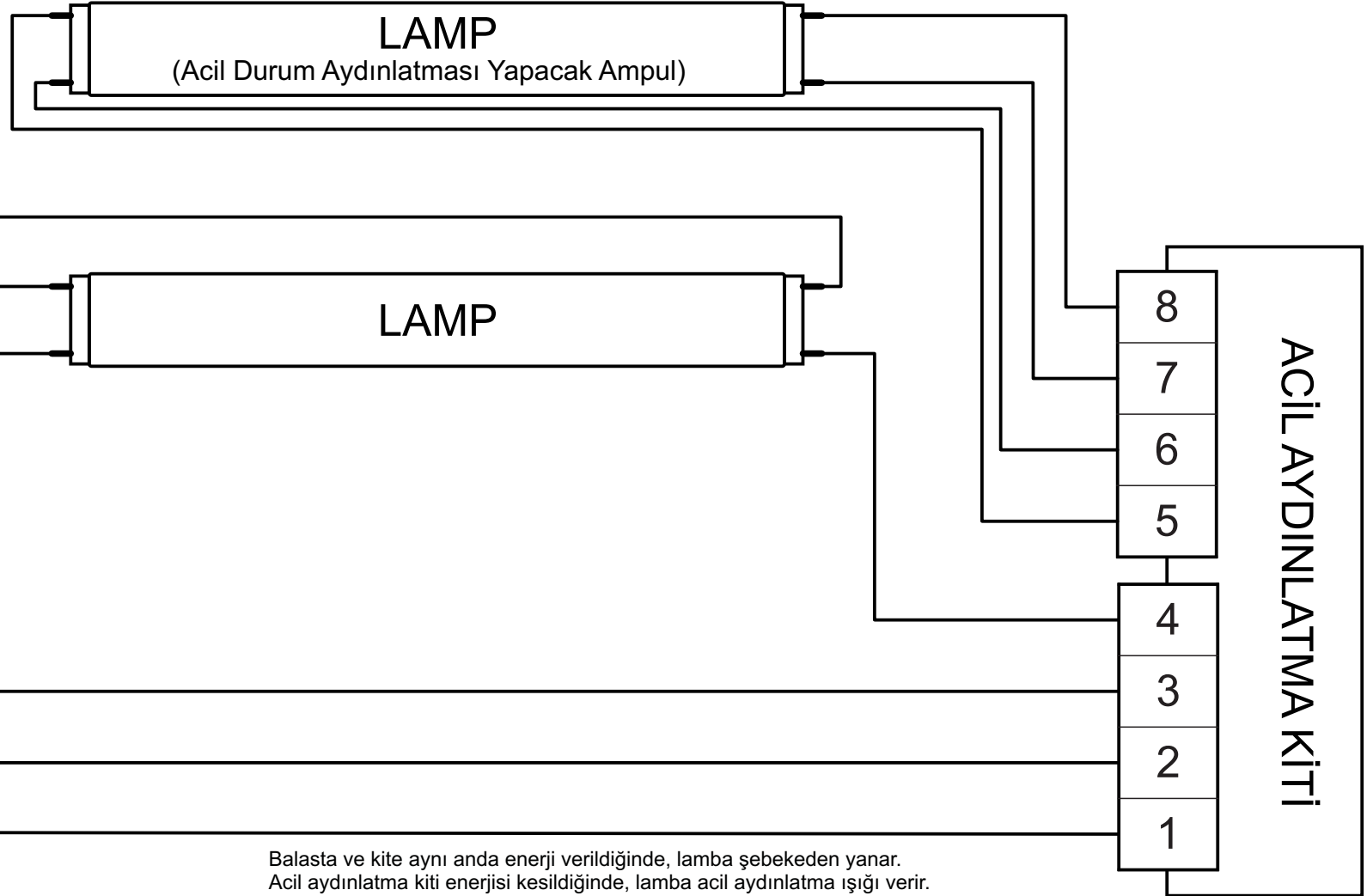
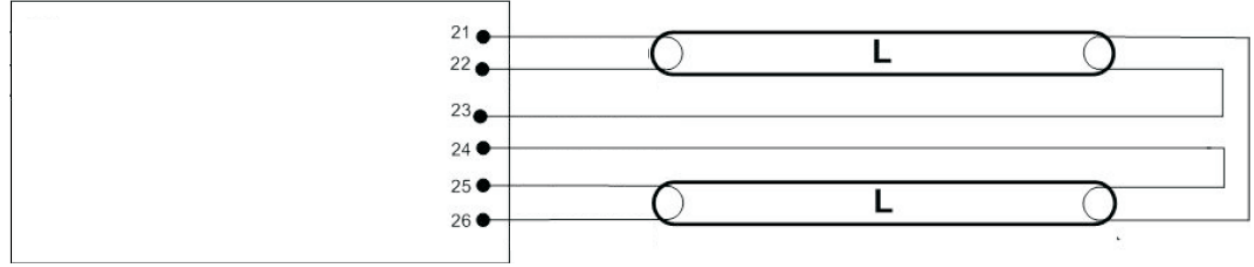

Balasta ve kite aynı anda enerji verildiğinde, lamba şebekeden yanar.
Acil aydınlatma kiti enerjisi kesildiğinde, lamba acil aydınlatma ışığı verir.

QT-FIT8 3x18 4x18 (3 Lamp operation)

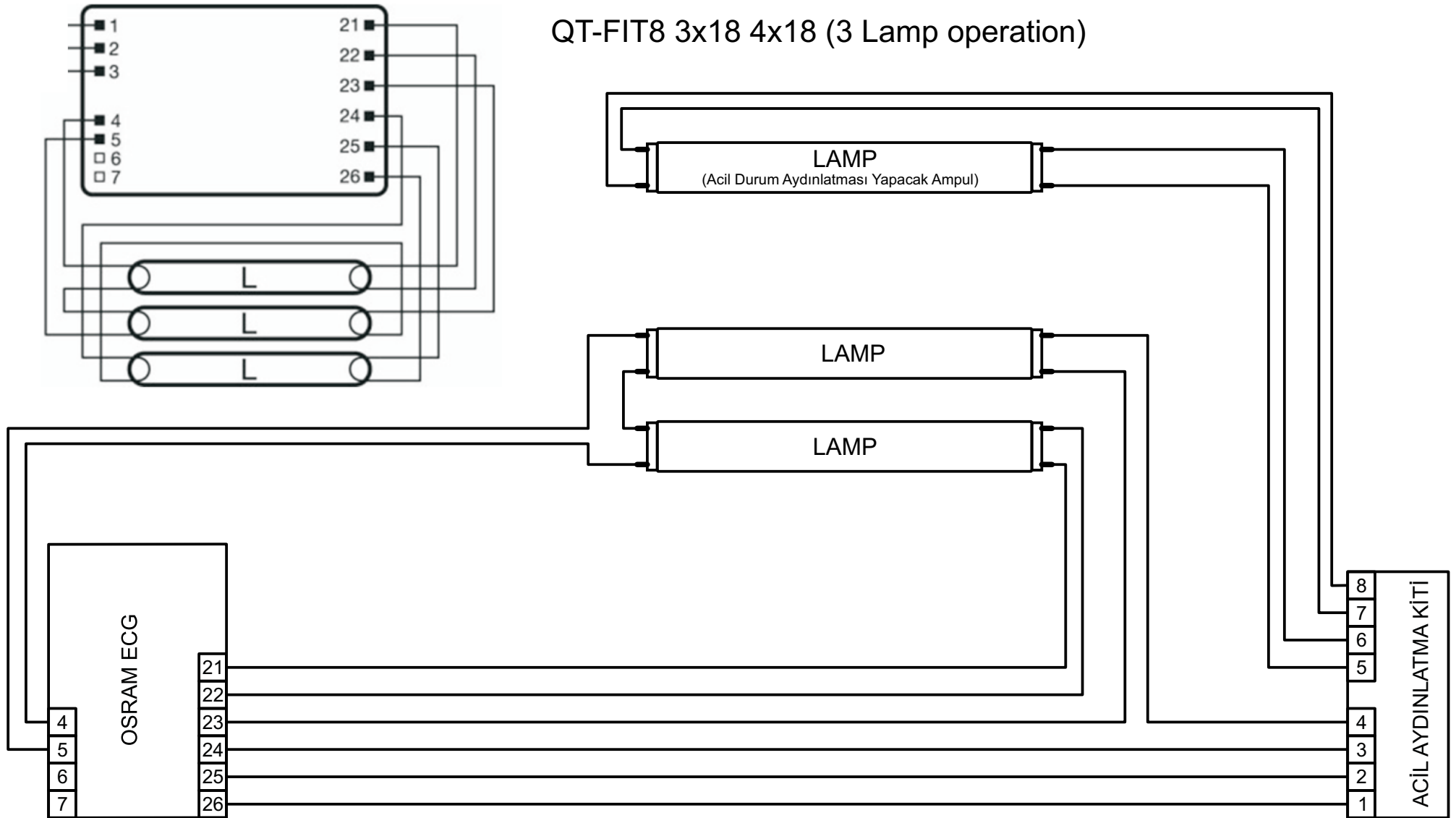

QT-FIT8 3x18 4x18 (4 Lamp operation)

